



---

**iAM-MIX-8**

**iAM-MIX-16**

**1RU, 8/16 of 64 Channel, Multi-Source Mixing  
Audio Monitor**

## **User Guide**

Part Number 821807, Revision J

---

© 2022 Wohler Technologies, Inc. All rights reserved.

This publication is protected by federal copyright law. No part of this publication may be copied or distributed, stored in a retrieval system, or translated into any human or computer language in any form or by any means electronic, mechanical, manual, magnetic, or otherwise, or disclosed to third parties without the express written permission of Wohler Technologies.

### **Reproduction**

Licensed users and authorized distributors of Wohler Technologies, Inc. products may copy this document for use with Wohler Technologies., Inc. products provided that the copyright notice above is included in all reproductions.

### **Customer Support**

Wohler Technologies, Inc.  
1280 San Luis Obispo Ave  
Hayward, CA, 94544  
Phone: 510-870-0810  
Web: [www.wohler.com](http://www.wohler.com)  
Sales: [sales@wohler.com](mailto:sales@wohler.com)  
Support: [support@wohler.com](mailto:support@wohler.com)

### **Disclaimers**

Even though Wohler Technologies, Inc. has tested its equipment and software, and reviewed the documentation, Wohler Technologies, Inc. makes no warranty or representation, either express or implied, with respect to software, documentation, their quality, performance, merchantability, or fitness for a particular purpose.

In no event will Wohler Technologies, Inc. be liable for direct, indirect, special, incidental, or consequential damages resulting from any defect in the hardware, software, or its documentation, even if advised of the possibility of such damages.

Some states do not allow the exclusion or limitation for incidental or consequential damages, so the above exclusion or limitation may not apply to you.

### **Other Technologies and Products**

Google Chrome is a registered trademark of Alphabet Inc. Microsoft Windows and Internet Explorer are registered trademarks of Microsoft Corporation.

Dante and Brooklyn are registered trademarks of Audinate Pty Ltd.

Ravenna is a registered trademark of ALC NetworX GmbH.

Bach is a registered trademark of CoveloZ.

ZMAN and Aneman are registered trademarks of Merging Technologies.

Evertz is a registered trademark of Evertz Microsystems, Ltd.

Grass Valley is a registered trademark of Grass Valley, a Belden brand.

All product names, logos, and brands are property of their respective owners. All company, product and service names used in this document are for identification purposes only. Use of these names, logos, and brands does not imply endorsement.

### **Last Update**

August 18, 2022

# TABLE OF CONTENTS

---

## Contents

User Guide .....	1
TABLE OF CONTENTS .....	3
Contents .....	3
CHAPTER 1: Installation .....	6
Introduction .....	6
Overview .....	6
Safety .....	6
Instructions .....	6
Safety Symbols .....	7
Mounting .....	7
Heat Dissipation .....	7
Sympathetic Vibration .....	8
Mechanical Bracing .....	8
Electrical Interference .....	8
Power .....	8
Compliance .....	9
FCC .....	9
ICES-003 .....	9
CHAPTER 2: Local Operation .....	10
Startup .....	10
Front Panel .....	10
Rear Panel .....	12
SFP-2022-6 / SFP-2110 Address Setup .....	15
Channel Displays .....	16
Preset / Config Menu .....	16
Preset Selection .....	17
Product Information .....	17
Set DHCP IP .....	17
Set Static IP Address .....	17
Set Input Source .....	18
Load Preset Configuration from USB Flash Drive .....	18
Factory Reset .....	18
CHAPTER 3: Technical Info .....	20
CHAPTER 4: Using the iAM-MIX Web GUI .....	24
Web Browser / Control Device .....	24
First Time- IP Assignments .....	24
Peer-to-Peer Connection .....	24
Network Connection .....	25
Dashboard .....	26

Sign In .....	27
Remote Monitoring .....	28
Configuration - Preset Setup .....	29
Common Output Routing .....	33
Destination Outputs .....	33
Routing Inputs .....	34
Output Options .....	35
Preset Output Routing .....	36
Typical Questions Regarding Output Routing .....	37
How do I route sources being audibly monitored to the XLR and AES outputs? .....	37
How do I output pre-fade signals on one output and post-fade outputs on another? .....	37
How do I make some outputs follow Mutes and Solos while making other outputs ignore them?.....	38
How do I route only specific monitored channels to the Analog XLR outputs? .....	38
How do I configure outputs for Source Select options, without creating Presets?.....	38
How do I keep the internal speakers always muted and send audio only to the Analog XLR outputs?.....	39
How do I ensure that outputs get automatically muted when a headphone is inserted into the headphone jack? .....	40
Why are AES Pairs 1, 2, 3, and 4 in the Output Routing Matrix? .....	40
What are AoIP-Pair 30 and AoIP Pair 31? .....	40
How do I route signals to the Analog XLR Outputs in a way that Master Volume doesn't affect this output but Channel Volume and Mute/Solo does? 41	41
How do I make Channel Volume, but not Mutes or Solos, affect the output? 41	41
Configuration – Device Management .....	42
Configuration – Preset Management.....	43
Copying Presets from this Unit .....	44
Copying Presets from Files.....	45
Dirty Presets.....	46
Database Management.....	47
Export Presets .....	47
Import Presets .....	48
Scan Network-Discovery .....	49
Network Setup.....	49
System Setup .....	50
Factory Reset .....	54
Reboot System .....	55
<b>APPENDIX A: Software Upgrades.....</b>	<b>56</b>
Introduction .....	56
Download the Software .....	56
Installing the Software Locally .....	56
Updating an iAM-MIX Remotely .....	58
Updating Multiple iAM-MIX Units.....	59
<b>APPENDIX B: Dante Network Setup .....</b>	<b>62</b>
Introduction .....	62
What is in the iAM-MIX for Dante.....	62



Dante Device Setup .....	64
Dante Clock Selection .....	65
Channel Names.....	65
AES67 .....	66
Stream Destinations .....	68
Device Lock.....	68
Dante Firmware Upgrades .....	68
Additional Information .....	68
Dante™ Legal Disclosures.....	69
<b>APPENDIX C: Ravenna (Coveloz) Setup .....</b>	<b>70</b>
Introduction .....	70
What is in the iAM-MIX for Ravenna .....	70
RAVENNA-compatible talker/listener: .....	70
AVB Ethernet features: .....	70
BACH™ Controller Graphical User Interface:.....	71
Home Page.....	72
Configuration/Device Management.....	72
Controller Cloud.....	74
Sync .....	75
Source Streams .....	76
Stream Destinations .....	77
Patch Panel.....	78
Troubleshooting .....	78
Ravenna Firmware Upgrades.....	79
<b>APPENDIX D: Ravenna (ZMAN) Setup .....</b>	<b>80</b>
Introduction .....	80
What is in the iAM-MIX for Ravenna .....	80
RAVENNA-Compatible Talker/Listener.....	80
AVB Ethernet Features .....	80
Configuring the AOIP Merging Option Card .....	81
Getting Started   General Settings .....	82
Getting Started   PTP.....	83
Getting Started   Session Sources.....	84
Getting Started   Session Sinks .....	85
Getting Started   Session Info .....	86
Getting Started   Ins/Outs .....	87
Getting Started   I/O Router .....	87
Operation: .....	88
Connecting Remote Source to Local Sink .....	88
ZMAN Session Sinks .....	88
ZMAN Session Sources.....	90
ZMAN Updating .....	90
<b>APPENDIX E: API Documentation .....</b>	<b>91</b>
Introduction .....	91
API: Presets .....	91
HTTP Routing Table .....	127
Status Codes .....	127

# CHAPTER 1: Installation

---

## Introduction

### Overview

The iAM-MIX intelligent adaptable monitors are 1RU multichannel multi-source audio monitors with multiple standard copper connections and multiple SFP module options facilitating high density coax and optical fiber connections. They feature direct integration capability with Evertz, Tally, and Grass Valley routers for channel name synchronization. The iAM-MIX may also accept Audio over IP signals via an Ethernet connector. Refer to the Specifications section or contact Wohler Sales for more information for Audio over IP capabilities. The iAM-MIX may be optionally configured to allow routing of any inputs to almost any outputs.

The iAM-MIX has individual channel volume controls and mute switches. With certain exceptions related to master clock compatibility, any channel from any source stream may be audibly monitored and mixed with the other selected channels. The iAM-MIX is small, flexible, moderately priced, and simple to operate. Setup configurations can easily be copied to other iAM-MIX units using a flash drive or by making use of a network connection.

Setups are created with a web browser over a network connection. Each iAM-MIX can be configured with up to 64 Presets. Nothing about the configurations of those predefined setups can be changed from the front panel. This prevents less experienced or hurried operators from making accidental setup changes that could compromise their usage of the unit. It also reduces operator training to a minimum.

## Safety

### Instructions

1. Read, keep, and follow all of these instructions; heed all warnings.
2. Do not use this equipment near water.
3. Use only a dry cloth to clean the equipment.
4. Do not block any ventilation openings.
5. Do not install near any heat source such as a radiator, heat register, amplifier, or stove.
6. Do not attempt to plug the unit into a two-blade outlet (with only two prongs of equal width).

#### Important:

By design, this monitor will only plug into a three-prong outlet for your safety. If the plug does not fit into the outlet, contact an electrician to replace the obsolete outlet.

7. Protect the power cord from being walked on or pinched, particularly at plug connection source on the equipment and at the socket.
8. Use only the attachments/accessories specified by the manufacturer.
9. Unplug the equipment during lightning storms or when unused for long periods of time.
10. Refer all servicing to qualified service personnel. Servicing will be required under all of the following conditions:
  - a. The equipment has been damaged in any way, such as when the power-supply cord or plug is damaged.
  - b. Liquid had been spilled or objects have fallen onto the equipment.
  - c. The equipment has been exposed to rain or moisture.
  - d. The equipment does not operate normally.
  - e. The equipment has been dropped.

## Safety Symbols

### WARNING:

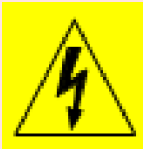

The symbol to the left warns of electric shock hazard inside the unit. Disconnect the power cord before removing access panels when installing upgrades. Only qualified service personnel are to operate the equipment with covers removed, and are to exercise caution to avoid personal injury.

## Mounting

The unit is designed for a standard 19" rack. Install it at ear/eye level for best high frequency response and visual observation of the display screens. Please adhere to the following clearances:

Table 1-1: Clearance Recommendations

Clearance	Surface
24"	Front
3"	Rear
2"	Sides
1.75"	Top and Bottom (if either radiates heat)
0"	Top and Bottom (if no heat)

## Heat Dissipation

The ambient temperature inside the mounting enclosure should not exceed 40° Celsius (104° Fahrenheit). Adjacent devices can be rack mounted (or stacked) in proximity to the unit if this temperature is not exceeded. Otherwise, allow a 1RU (1.75"/44.45mm) space above and below the unit for air circulation.

**Important**

Heat generated by the class D power amplifiers, power supplies, and other components is vented by slots in the sides and back of the unit. Therefore, as a safety precaution, you must allow proper ventilation on these surfaces.

**Sympathetic Vibration**

Sympathetic vibration from other equipment (cables, etc.) in the rack may be serious enough to interfere with the unit's sound quality. If you experience sympathetic vibrations, use thin card stock, felt, foam, or weather-stripping between the vibrating surfaces. Tie loose cables securely with cable ties.

**Mechanical Bracing**

The 1RU chassis is securely attached to the front panel. In addition, the chassis has mounting tabs through which you attach it to the rack rail. This feature will reduce or eliminate rear bracing requirements in many mobile/portable applications. The weight of internal components is distributed fairly evenly around the unit.

**Electrical Interference**

Be careful to avoid mismatched cable types and other similar causes of undesired reflections in digital signal systems. If severe enough, such reflections can result in corruption of the digital data stream. As with any audio equipment, maximum immunity from electrical interference requires the use of shielded cable; however, satisfactory results can sometimes be obtained without it. The internal circuitry ground is connected to the chassis.

**Power**

The unit comes with a standard 18 VDC / 3.9 A external power supply that connects to an AC mains power source (100 to 240 VAC, 1.5A, 50/60Hz) using an IEC power cord.

When the mains plug or appliance coupler is used as the disconnect device, the disconnect device should remain operable.

# Compliance

## **FCC**

This equipment has been tested and found to comply with the limits for a Class A digital device, pursuant to part 15 of the FCC Rules. These limits are designed to provide reasonable protection against harmful interference when the equipment is operated in a commercial environment. This equipment generates, uses, and can radiate radio frequency energy and, if not installed and used in accordance with the instruction manual, may cause harmful interference to radio communications. Operation of this equipment in a residential area is likely to cause harmful interference, in which case the user will be required to correct the interference at their own expense.

## **ICES-003**

This Class A digital apparatus complies with Canadian ICES-003.

Cet appareil numérique de la classe A est conforme à la norme NMB-003 du Canada.

# CHAPTER 2: Local Operation

## Startup

The iAM-MIX-8 and iAM-MIX-16 units (and their variants) take about a minute to become operational after power is applied. During that time, several status messages are shown spanning the displays on the front panel.

## Front Panel

The iAM-MIX-8 front panel is shown in Figure 2-1. The iAM-MIX-16 front panel is shown in Figure 2-2.

Figure 2-1: iAM-MIX-8 Front Panel

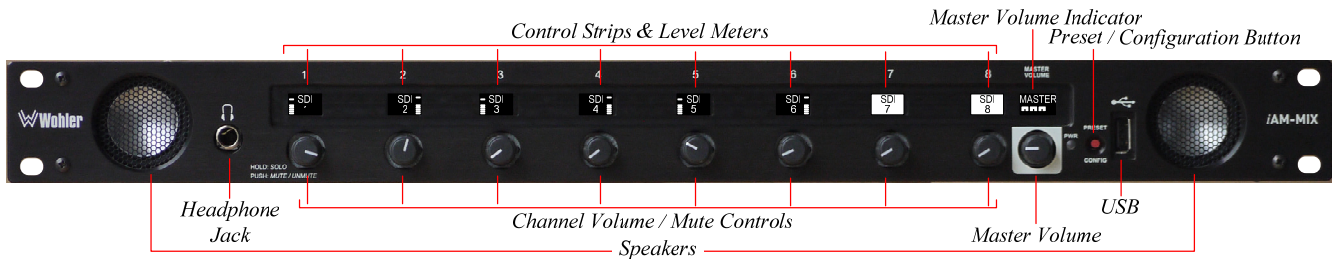
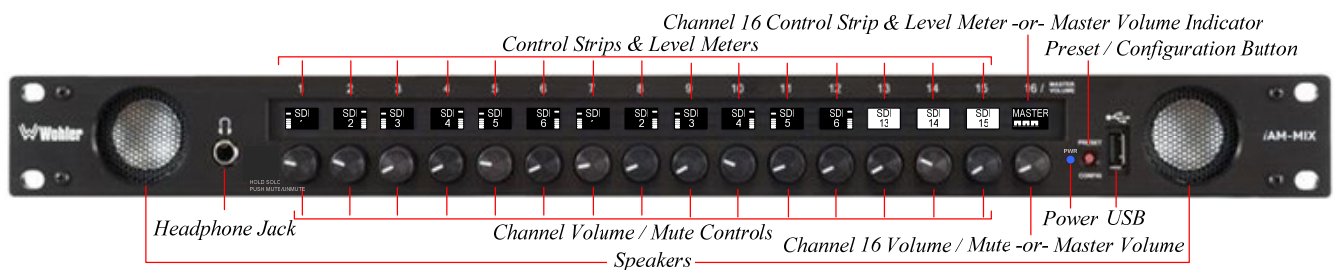

Figure 2-2: iAM-MIX-16 Front Panel



### Important:

The number (1-8 or 1-16) above the channel control strips does not indicate any particular source channel number or arrangement. Strip numbers only serve as references for channel configurations at the iAM-MIX Web GUI level. Different Presets typically have different channel numbers assigned to control strips.

The audio mixer terminology of “strips” is used in this manual when referring to the identification of the controls. The control strip display label default is to display the input type and channel number, but may be changed in the iAM-MIX Web GUI to show any displayable text or numbers.

1. **Speakers:** Audio monitoring is achieved through the use of class D amplifiers driving two (left/right) wide range speakers.
2. **Headphone Jack:** A 1/4" jack for an optional headphone is provided on the front panel. Speaker audio mutes when headphones are plugged in.
3. **Channel Volume/Mute:** Rotating each **Channel Volume/Mute** control adjusts the individual level of each corresponding channel. Pressing this control knob alternately mutes or unmutes the associated channel. Holding the control knob pressed for two seconds solos the associated channel and mutes all others.
4. **Master Volume:** This control adjusts the level of the entire mix. Note that while there is a dedicated **Master Volume** control on the iAM-MIX-8, the iAM-MIX-16 incorporates a control that can be set up to be either a **Master Volume** control or a 16th **Channel Volume/Mute** control. When the control is optioned to be a **Master Volume**, it control the volume of all of the channels, including channel 16. Pressing a Master Volume control alternately mutes or unmutes the entire mix.
5. **Control Strips and Level Meters:** These miniature displays identify each **Channel Volume/Mute** control and provide a basic 10-segment level meter for each channel. The displays will automatically dim if the none of the front panel controls have been used for an hour, but will brighten again when any control is adjusted. Refer to the **Channel Displays** section of this chapter for further information on the functions of the **Control Strips and Level** Meters.
6. **Preset/Config Button:** Pressing this button activates a menu for Preset selection and configuration status information. Refer to the **Preset/Config Menu** section of this chapter for a description of how to use this button.
7. **USB:** This USB 2.0 Type A connector allows you to use a flash drive (not supplied) to perform software updates or copy system configurations to another iAM-MIX or to a PC.
8. **Power Indicator:** The **Power** indicator lights blue whenever the iAM-MIX is connected to power.

# Rear Panel

The iAM-MIX-8 and iAM-MIX-16 rear panels are shown in Figure 2-3. They are identical. Some variants may not contain all options (e.g. the MADi only unit).

Figure 2-3: Rear Panel Layout

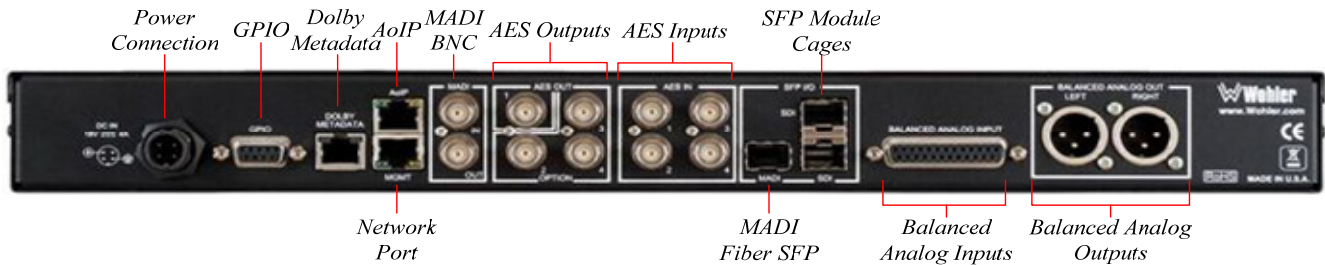

1. **Power Connection:** The iAM-MIX uses an external AC to 18V DC power adapter. The AC inlet of the adapter is a standard IEC receptacle for 100 to 240 VAC  $\pm 10\%$ , 50/60 Hz power connection. Four regional AC power cords, supplied per shipping region, are available.

## Important:

By design, the supplied AC mains power cord will only plug into a three-prong grounded outlet for your safety. If the plug does not fit into the outlet, contact an electrician to replace the obsolete outlet.

## Important:

The monitor and power adapter have been tested as a combined apparatus to verify compliance with applicable safety and electromagnetic compliance standards. Use of another power adapter provided by the user may negate the compliance or cause the monitor to not perform properly. Wohler Technologies cannot accept any responsibility for the outcome in such cases.

2. **GPIO:** *(future implementation)* This DB-9 connector provides 2 input pins and 2 output pins to perform GPIO functions as defined by the iAM-MIX Web GUI.
3. **Network Port:** This Ethernet port can connect to either a LAN or to a PC to let you customize the iAM-MIX configuration. It will also allow you to copy system configurations from one iAM-MIX to another. It can also be used to update the iAM-MIX software and firmware.
4. **AoIP:** This Ethernet port can accept either a Dante or a Ravenna Audio over IP signal. There are different hardware option cards for each signal and the appropriate/desired capability must be specified at order.
5. **MADI BNC:** This COAX input accepts an AES10 64-channel signal at 48 kHz sample rate. The COAX output is reclocked from the MADI source. When power to the iAM-MIX is not present, the COAX input and output



are automatically connected together to allow the MADI signal to pass through.

6. **MADI Fiber SFP:** (optional) This input module accepts an optical AES10 64-channel MADI input signal at 48 kHz sample rate. The SFP fiber module may be used in conjunction with the MADI BNC connectors to provide COAX to fiber or fiber to COAX conversion. The outputs are reclocked. A software license must be installed for the SFP port to function. Refer to the **System Setup** section in Chapter 4 and to Figure 4-8 to install software licenses.
7. **Dolby Metadata:** This output is not implemented at this time.
8. **AES Out:** By default, the BNC AES-1 jack outputs the same mixed audio as the XLR analog outputs, as heard from speakers or headphones, but as an AES3id pair. Other options may be set in the iAM-MIX Web GUI. AES 2-4 jacks may be used with Common Output Routing, a licensable feature described in Chapter 4.
9. **AES In:** These four BNC jacks accept AES3id digital audio pairs at 48 kHz sample rate. Channels are selected as AES 1-8.
10. **SFP Module Cages:** The two SFP cages are provided to accept one or two optional SFP modules compatible with SDI coaxial or optical signals. Single or dual transceiver arrangements are possible. The SFP modules are swappable for convenience. The iAM-MIX must be powered off while inserting an SFP module or else it must be power cycled after insertion. An optional license key must be purchased to enable each module. A software license must be installed for an SFP port to function. Refer to the **System Setup** section in Chapter 4 and to Figure 4-8 to install software licenses. The following SFP modules are offered:
  - a. **3G/HD/SD-SDI Single Video Receiver with Active Loopback:** This uses HD-BNC connectors.
  - b. **3G/HD/SD-SDI Video SFP with Optical Input:** This uses LC fiber connectors. It is a Single-Mode Receiver, Medium Haul, Non-MSA, and no output.
  - c. **3G-SDI Transceiver:** This uses HD-BNC connectors. Input and output are both SDI.
  - d. **SMPTE 2022-6 Receiver:** This uses Multi-Mode 850 NM, LC fiber connectors. It allows the iAM-MIX to monitor SDI audio transmitted in real time over Ethernet. You must use the MN-Set configuration software to set up this option. It is available from Wohler Technologies Technical Service.
  - e. **SMPTE 2110 Receiver:** This uses Multi-Mode 850 NM, LC fiber connectors. It allows the iAM-MIX to monitor SDI audio transmitted in real time over Ethernet. You must use the MN-Set configuration software to set up this option. It is available from Wohler Technologies Technical Service.

- f. **SMTPE 2110 or 2022-6 Receiver:** This uses Multi-Mode 850 NM, LC fiber connectors. It allows the iAM-MIX to monitor SDI audio transmitted in real time over Ethernet. You must use the MN-Set configuration software to set up this option. It is available from Wohler Technologies Technical Service.
11. **Analog Inputs:** This DB-25 female connectors accepts +10dBu broadcast level balanced audio. Tascam pinout cables may be used, and can be purchased Wohler Sales. Refer to Figure 2-4 for the pinout of this connector.

Figure 2-4: Analog DB25 Input Connections

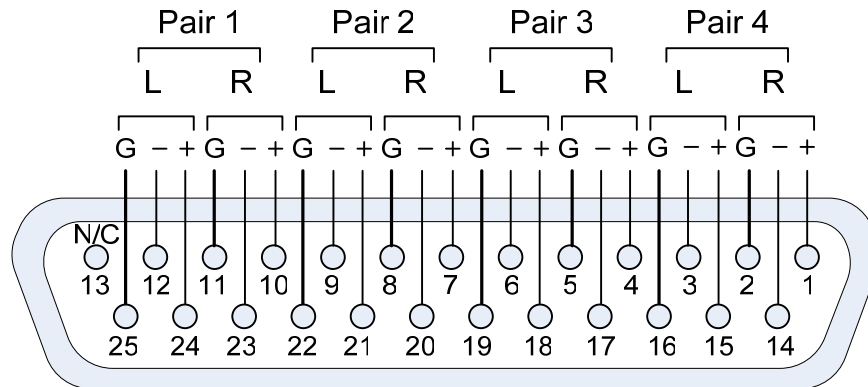

12. **Analog Outputs:** These male XLR connectors provide two balanced analog outputs: **Left** and **Right**. The source of these signals is the mix of audio as monitored by the internal speakers. If the licensed Common Output Routing feature is installed, these outputs can be configured to supply virtually any mix of input signals. This is described in Chapter 4.

Figure 2-5: Analog XLR Output Connections

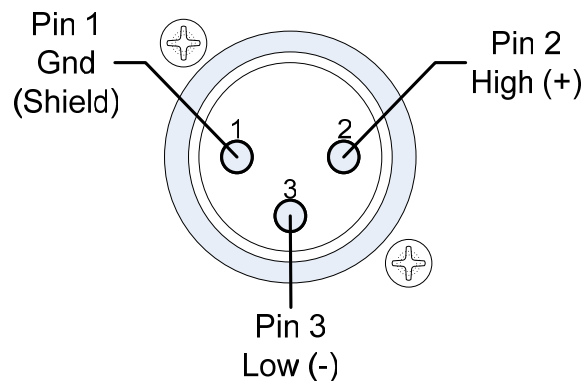

## SFP-2022-6 / SFP-2110 Address Setup

While the optional SFP-2022-6 and SFP-2110 modules monitor program audio created from distinctly different technologies, both are connected to the network in the same way and have the same requirements for addressing. Figure 2-6 illustrates the network connections they need.

Figure 2-6: SFP-2022-6 and SFP2110 Network Diagram

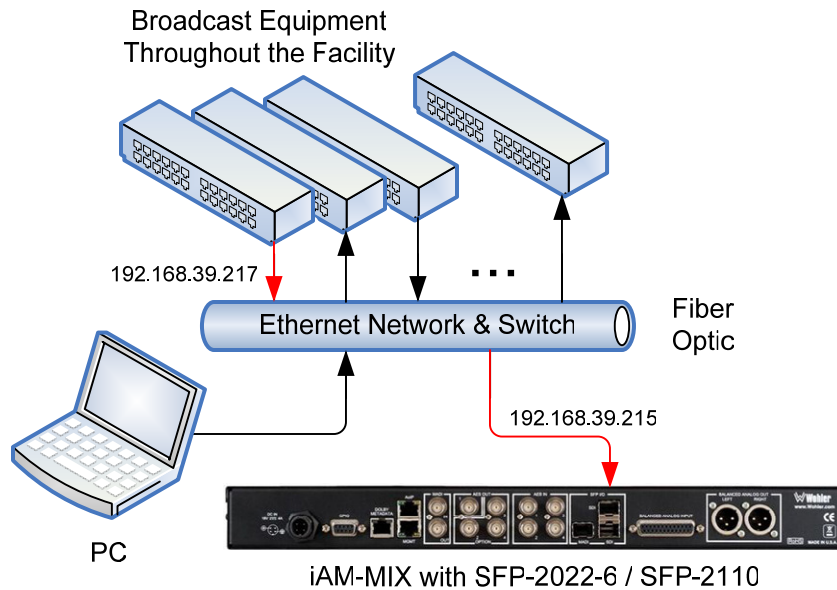

The optional SFP-2022-6 or SFP-2110 module furnished by Wohler Technologies is manufactured by Embrionix and comes from the factory with a default IP address. To integrate it into your digital network, you need to set its address to the source to be monitored. You must use the MN-Set configuration software to set up this option. It is available from Wohler Technologies Technical Service. The procedure to accomplish this is described in the **SFP-2022-6 / SFP-2110 Setup Guide** (part number 821822), which is available at <https://wohler.com/downloads/>.

# Channel Displays

Display information for each channel strip is shown in Figure 2-7 below.

Figure 2-7: Strip-Channel Display

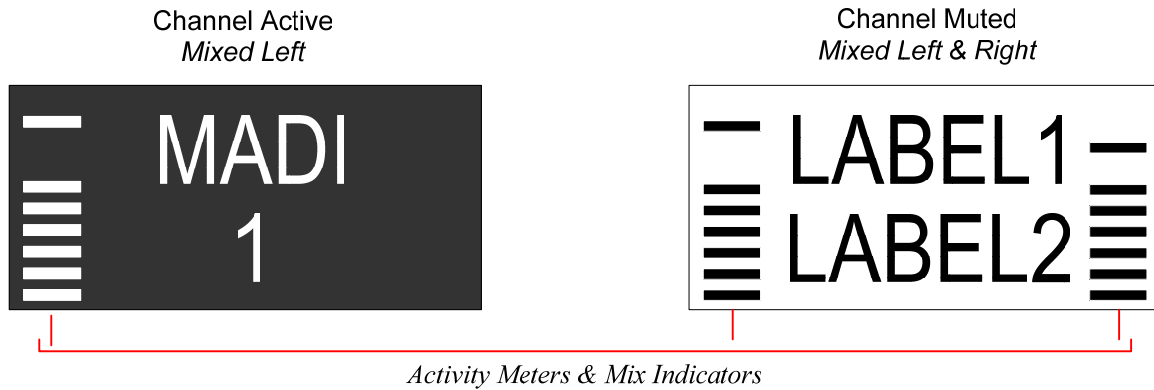

1. **Activity Meters:** The activity of the 10-segment bar graph meters provides a quick indication of signal presence. A floating peak bar above an average level stacked bar is also shown. The meter left/right position(s) indicates left/right Mix Assignments. Both left and right meters are displayed when a mono source channel is being sent to both sides of the speakers, headphones and outputs.
2. **Mute:** When a channel is muted, the entire display is inverted for reverse video, so that it will have a white background with black labels and meters.
3. **Strip Labels:** Two lines of text can be used to identify the audio source by name, channel number, or other information. Evertz, Tally, or Grass Valley integration can be used to automatically fill in these labels. Refer to the **Configuration - Device Management** section of Chapter 4.
  - a. Five or six upper case letters or numbers will typically fit on each line. Since text character widths vary, the exact number of characters displayed can vary. The right edge may get cut off if very wide characters are entered.
  - b. Lower case text characters are displayed as smaller capital letters (small caps) to allow more characters to be displayed.

## Preset / Config Menu

Operators can select between up to 8 Presets in the iAM-MIX-8 or 16 Presets in the iAM-MIX-16 or access several control or informational screens by pressing the **PRESET / CONFIG** button on the front panel. It is recessed to prevent accidental activation. When the button is pressed, the menu shown in Figure 2-8 appears. Figure 2-8 depicts the menu as it appears on an iAM-MIX-8. The menu on the iAM-MIX-16 is very similar. If the **PRESET / CONFIG** button is accidentally pressed, pressing either **EXIT MENU** or **PRESET / CONFIG** again will exit the menu and return to normal monitor operation, unchanged. It takes about 3 seconds to exit

this or any other menu.

Figure 2-8 Preset / Config Menu



The following describes the function and operation of each menu control shown in Figure 2-8:

### Preset Selection

Pressing the control directly below **SELECT PRESET** will display up to 8 (for the iAM-MIX-8) or 16 (for the iAM-MIX-16) of the available Favorite Presets by name. The current Preset will be highlighted in reverse video. Press it to exit the menu with no changes. To select a new Preset, press the control corresponding to the name of the Preset you choose. It will take approximately 3 seconds to recall the Preset, and then the Channel Strip will return to its normal indications.

Note that if no Favorite Presets have been set up using the Web GUI, then up to 8 or 16 of the other Presets will be displayed. If no Presets have been set up, no Presets will be displayed.

### Product Information

Pressing **SHOW INFO** shows the software revision and serial number. It also shows the static or dynamic IPv4 address currently allocated. Press **EXIT MENU** to return to normal monitor operation when you are finished reading this information.

### Set DHCP IP

Press **SET IP DHCP** to change the IP address mode to DHCP. A menu will appear offering the choice of **REBOOT DHCP** or **CANCEL NO CHG**. Press **CANCEL NO CHG** or **EXIT MENU** to exit this menu with no IP address changes or press **REBOOT DHCP** to change the IP address mode to DHCP and reboot the iAM-MIX.

**Note:** If the network does not have a DHCP server, then the iAM-MIX may take longer to reboot.

### Set Static IP Address

Press **SET IP STATIC** to change the IP address mode to Static and then enter a new static IP address. To change the network address, use the following steps:

1. Rotate the leftmost **ADDR <TYPE>** knob so that it says **ADDR**. The upper characters of the next four knobs will show the current IP address or last saved address.
2. Rotate each of the next four knobs to select the new address. The newly entered address will appear on the lower characters of these knobs, while the current address will still appear on the upper characters for your reference. When finished entering the address, press **SAVE CHANGE**.
3. Rotate the leftmost knob so that it says **MASK**. The upper characters of the

next four knobs will show the current mask.

4. Rotate each of the next four knobs to select the new mask. The newly entered mask will appear on the lower characters of these knobs, while the current mask will still appear on the upper characters for your reference. When finished entering the mask, press **SAVE CHANGE**.
5. Rotate the leftmost knob so that it says **GTWY**. The upper characters of the next four knobs will show the current gateway.
6. Rotate each of the next four knobs to select the new gateway. The newly entered gateway will appear on the lower characters of these knobs, while the current gateway will still appear on the upper characters for your reference. When finished entering the gateway, press **SAVE CHANGE**.
7. Rotate the leftmost knob so that it says **DNS**. The upper characters of the next four knobs will show the current DNS.
8. Rotate each of the next four knobs to select the new DNS. The newly entered DNS will appear on the lower characters of these knobs, while the current DNS will still appear on the upper characters for your reference. When finished entering the DNS, press **SAVE CHANGE**.

At this point, you may rotate the leftmost knob to review or possibly correct any of the address entries you have made. To apply the changes you have made, press **REBOOT NEWADR**. The iAM-MIX will reboot with the new address.

To exit and cancel the changes you have made, press **EXIT MENU**.

## Set Input Source

Press **SET INP SOURCE** to select the input source you would like to monitor from among the licensed inputs. Press one of the choices given. Another menu may appear to allow you to select from among the inputs of your chosen source.

To exit without selecting a different input source, press **EXIT MENU**.

## Load Preset Configuration from USB Flash Drive

iAM-MIX configurations can be saved to a USB flash drive from the Web GUI. This allows you to easily set up several iAM-MIX units exactly the same way. Press **GETUSB CONFIGS** to load a new system configuration that you have saved on a USB flash drive. Two choices appear: **Rd USB No** and **Rd USB Yes**. Insert a USB flash drive with a system configuration file on it and press **Rd USB Yes**. Further choices will appear to allow you to select the new configuration. If there is no USB flash drive inserted or if no configuration file can be found, an error message appears and the menu exits.

If you would like to exit the menu, press **Rd USB No** or **EXIT MENU**.

## Factory Reset

It can be useful to bring all of the settings of the iAM-MIX back to the way they were when it left the Wohler factory if the iAM-MIX is being reinstalled at a new location. Press **FACTORY RESET** to begin the process. The choices **RESET NO?** and **RESET YES?** appear.

To continue with the factory reset, press **RESET YES?** The iAM-MIX will reboot with its original settings.

To cancel the reset process, press **RESET NO?** or press **EXIT MENU**.

# CHAPTER 3: Technical Info

Table 3–1: iAM-MIX Specifications

Specification	Values/Domains
Power Requirements	100 V to 240 V AC $\pm$ 10%, 50/60Hz
Power Consumption	40 Watts
Dimensions (H x W x D)	1.75" x 19" x 6.5" (44mm x 483mm x 165mm)
Weight	8 lbs. (3.6 kg)
Supplied Accessories	Power Adapter, AC Power Cord
Display Type	Passive Matrix OLED
Number of Displays	9 or 16
Screen Resolution	64H x 32V
Sample Rate	48kHz
De-Multiplexing	16 channels from: <ul style="list-style-type: none"> <li>• 16-channel SD/HD/3G-SDI</li> <li>• 64-channel AES10 MADI</li> </ul>
SDI Inputs / Outputs	<ul style="list-style-type: none"> <li>• 1 or 2 SDI Inputs or Outputs</li> </ul> Optional – Single SFP Transceiver: <ul style="list-style-type: none"> <li>• HD-BNC Coax 3G/HD/SD-SDI</li> <li>• Multi-Mode Fiber: 1 SI Optical SC-Connector, 1300nm</li> <li>• Single-Mode Fiber: 1 SI Optical SC Connector, 1310nm</li> </ul>
MADI Inputs / Outputs	<ul style="list-style-type: none"> <li>• 1 MADI BNC, Standard Coax I/O</li> </ul> Optional – SFP Transceiver: <ul style="list-style-type: none"> <li>• Multi-Mode Fiber: 1 MADI Optical SC-Connector, 1300nm</li> <li>• Single-Mode Fiber: 1 MADI Optical SC Connector, 1310nm</li> </ul>
Analog Inputs / Outputs	<ul style="list-style-type: none"> <li>• 8 Balanced Analog Inputs on DB-25 are standard with every unit.</li> <li>• 2 Balanced Analog Outputs of monitored signal on XLR are standard with every unit.</li> </ul>
AES Inputs / Outputs	<ul style="list-style-type: none"> <li>• Inputs: 8 AES channels on 4 BNC are optional</li> <li>• Output: 2-8 AES channels of monitored signal on 1-4 BNC is optional</li> </ul>
Audio over IP Input / Output	Ethernet AoIP I/O accepts either an optional <ul style="list-style-type: none"> <li>• Dante/AES67 capable signal, or</li> <li>• Ravenna/AES67 signal</li> </ul>
Cable/Fiber Length (max)	COAX (such as Belden 1694A): > 150 m
	Multi-mode fiber: 1 km
	Single-mode fiber: 10 km



Specification	Values/Domains
SDI Input Termination	75Ω unbalanced
AES/EBU Input Termination	75Ω unbalanced
Analog Input Impedance	40kΩ balanced
AES/EBU/MADI Sampling Rate	48 kHz
Analog Outputs-Stereo	XLR-3 Male, balanced +24dBu max
Analog Output Frequency Response	40 Hz to 20 kHz (± 1dB)
Analog Output Distortion	<0.01% THD+N
Analog Output Dynamic Range	>100 dB
Analog Output Reference Level	-20 dBFS = +4 ± 1.0 dBu
Internal Speakers - Stereo	40mm Full Range
Peak Acoustic Output	90dBA SPL (@ 2 feet)
Power Output	4 Watts RMS, 8 Watts peak (each side)
Acoustic Frequency Response	150 Hz to 16 kHz (± 5 dB)
Headphone Out - Stereo	40 Hz to 20 kHz (± 1dB)
Headphone Load	8Ω to 150Ω

Table 3-2: iAM-MIX Processing Options

Option	Part #	Description
OPT-DANTE	829078	Enables decoding and monitoring of Dante™ Input streams.
OPT-RAVENNA	829079	Enables decoding and monitoring of Ravenna™ Input streams.

Table 3–3: iAM-MIX I/O Options

Option	Part #	Description
SFP-Madi-MM-Fiber	829081	MADI optical fiber transceiver. Multi-Mode, LC (fiber) connectors. SFP module with software activation key.
SFP-Madi-SM-Fiber	829082	MADI optical fiber transceiver. Single-Mode, LC (fiber) connectors. SFP module with software activation key.
SFP-SDI	829089	3G/HD/SD-SDI single video receiver with active loopback, HD-BNC connectors. SFP module with software activation key.
SFP-SDI-Fiber	829084	3G/HD/SD-SDI video SFP optical input; LC (fiber) connectors; Single-Mode Receiver, Medium Haul, Non-MSA, no output; with software activation key.
SFP-2022-6	829088	SMTPE 2022-6 receiver; Multi-Mode 850 NM, LC (fiber) connectors. SFP module with software activation key. Use MN-Set** to configure SFP.
SFP-2110	829086	SMTPE 2110 receiver; Multi-Mode 850 NM, LC (fiber) connectors. SFP module with software activation key. Use MN-Set** to configure SFP.
OPT-AES	829080	Enables decoding and monitoring of 8 AES input channels on 4 BNC connectors. Requires a software activation key.
OPT-MADI	829092	Enables decoding and monitoring of 1 x MADI64 input on a BNC connector. Requires a software activation key.
OPT-ANLG	829093	Enables monitoring of 8 balanced Analog inputs on a DB-25 connector. This is a standard feature, so the software activation key is included.
OPT-OUTPUT ROUTING	829159	Enables the ability to flexibly route input signals to various outputs. Requires a software activation key.

\*\*MN-Set is configuration software that is necessary so that you can set up this module. It is available at no cost either from its manufacturer, Embrionix, or by contacting Wohler Technologies Technical Service.

Figure 3-1: iAM-MIX Block Diagram

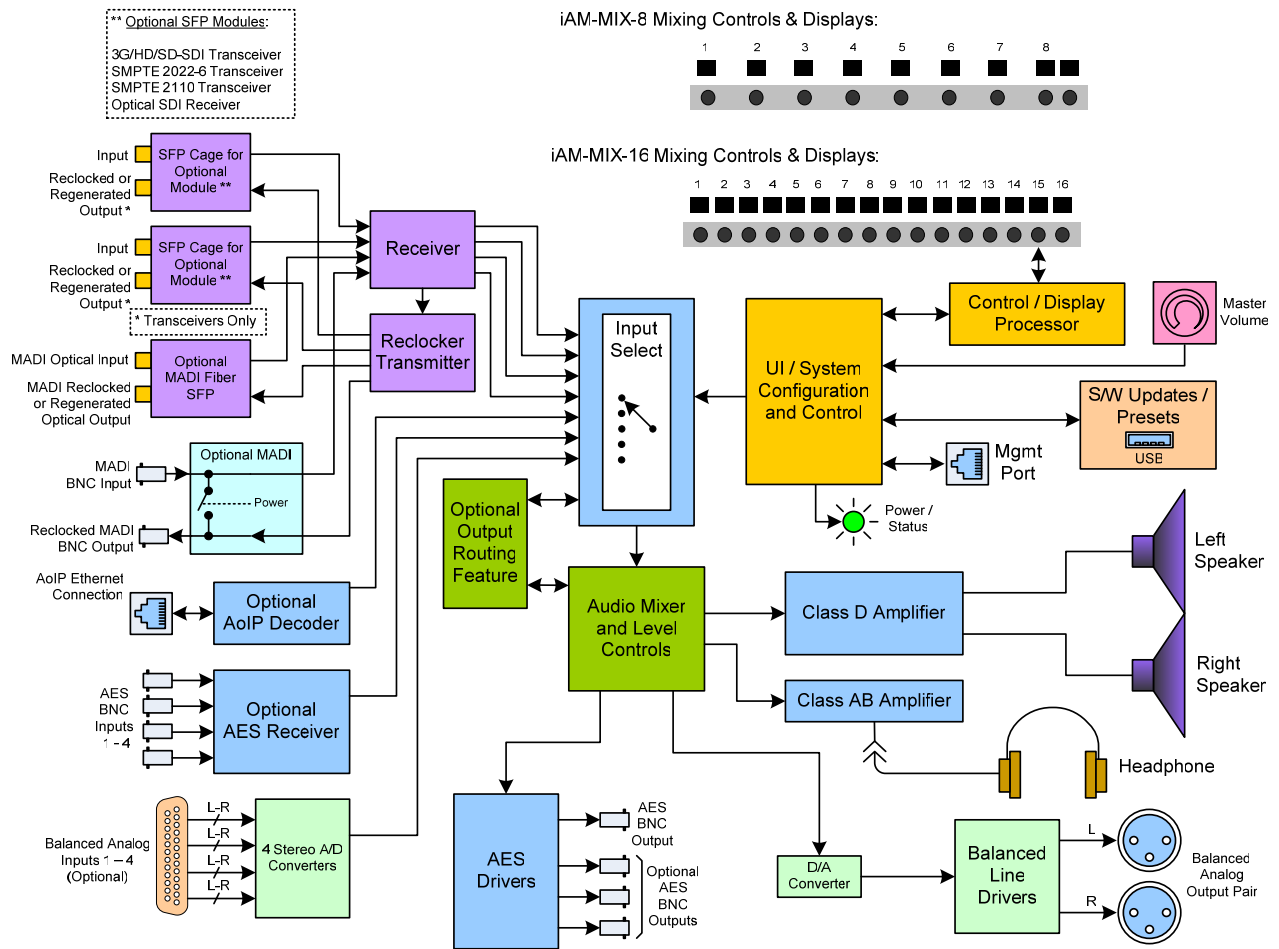

# CHAPTER 4: Using the iAM-MIX Web GUI

---

The iAM-MIX Web GUI allows you to customize the monitor's configuration to suit your needs. If the default configuration of the iAM-MIX suits your needs and you prefer to use it that way, then you do not need to use the iAM-MIX Web GUI.

## Web Browser / Control Device

Any web browser application running on any networked device such as desktop or laptop computer, tablet or smart phone can be used with the iAM-MIX Web GUI.

Tablets would need to be linked to a copper LAN through a Wi-Fi adapter if the tablet has no network connector.

Phones are not recommended due to their smaller screen size that will require more scrolling.

The Chrome<sup>®</sup> web browser is recommended for speed and compatibility.

## First Time- IP Assignments

The iAM-MIX can operate with a static (fixed) or dynamic (DHCP) IPv4 address. The address will be **172.27.2.2** when received from the factory or when switched from DHCP to static addressing mode. There are two basic types of connections that may be used to connect the iAM-MIX to a web browser, a **Peer-to-Peer Connection** or a **Network Connection**.

### Peer-to-Peer Connection

The most straightforward way to connect the iAM-MIX to a web browser, free of possible network conflicts, is to establish a static peer-to-peer connection between the setup computer and the iAM-MIX. A 10/100/1000 MHz Ethernet switch may be used in between, but is not required.

Figure 4-1 shows an example of suitable address settings for the host computer in a Windows 7 control panel.

Figure 4–1: Host IP Settings

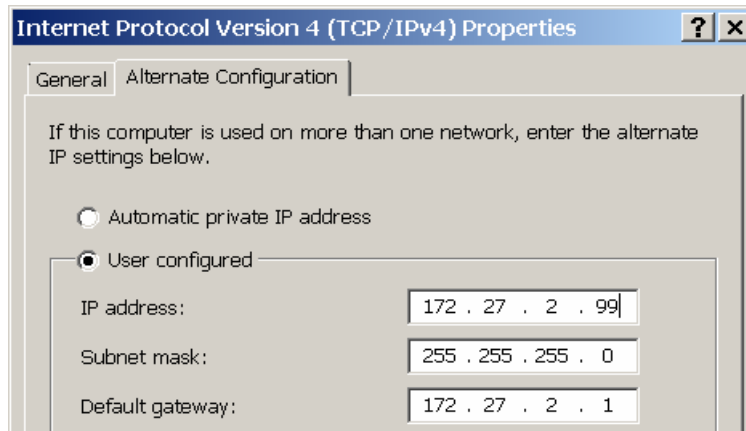

Close the control panel and reboot the host computer after making an IP address change to be sure the change takes effect. **Either reconnect to the installed network or continue with this direct connection to access the iAM-MIX Web GUI.**

## Network Connection

When connected to a network, the iAM-MIX address will need to be changed to another address in order to be compatible with the address assignments for that particular network. Immediately after the host setup is complete, change the address of the iAM-MIX. Make the corresponding address, mask and gateway changes in the iAM-MIX **Network Setup** page. Refer to the **Network Setup** section of this chapter and Figure 4-11.

Otherwise set the iAM-MIX to DHCP address mode by checking the box for 'Use DHCP?' in [Network Setup](#) and have your IT administrator assign rights and settings for operation on the network. Allow enough time for your network's DHCP server to recognize a new network device and assign an address after booting.

# Dashboard

Throughout the iAM-MIX Web GUI, other pages are a click or two away on the left side. The Dashboard/Presets Overview on the Dashboard page shows all Preset configurations at a glance.

Figure 4–2: Dashboard/Presets Overview

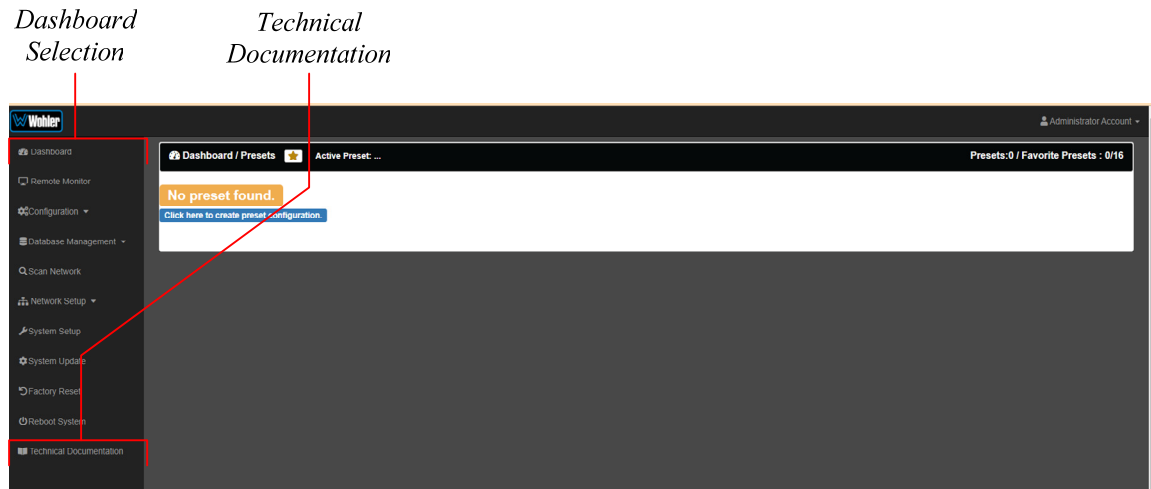

The name of the currently active Preset is shown at the top. All of the Presets are shown below. Any Preset can be made active by clicking the Recall button. By clicking the Information symbol to the right of any Preset, while signed in as described in the next section, the Preset can be Renamed, Deleted, or made a Favorite. The green star button is the Favorite button. If any Presets are selected as Favorites, they will appear in the Preset Selection menu of the iAM-MIX, and operators can easily access them. Up to 8 Favorite Presets can appear in the iAM-MIX-8 menu and up to 16 Favorite Presets can appear in the iAM-MIX-16 menu. In this way, you can select just the Presets most useful to the operator out of the 64 possible Presets.

No other changes to the configuration of a Preset can be made on this screen. Click on **Configuration - Preset Setup** in the left navigation pane to make Preset changes.

Note that the last selection in the list on the left is **Technical Documentation**. This may be selected from any page to allow you online access to this manual, including the API Documentation.

# Sign In

Only authorized users should be allowed to make Preset and network changes. Anybody can view the status of iAM-MIX units on the network, but logging in with a password is required to make any changes. When logging in is required to make a change, the page shown in Figure 4-3 will appear. Alternatively, login can be done at any time by clicking on **Administrative Account** selection in the upper right portion of the browser page and clicking **Log In**.

Figure 4–3: Administrative Account Log In

*Administrator Account Selection*

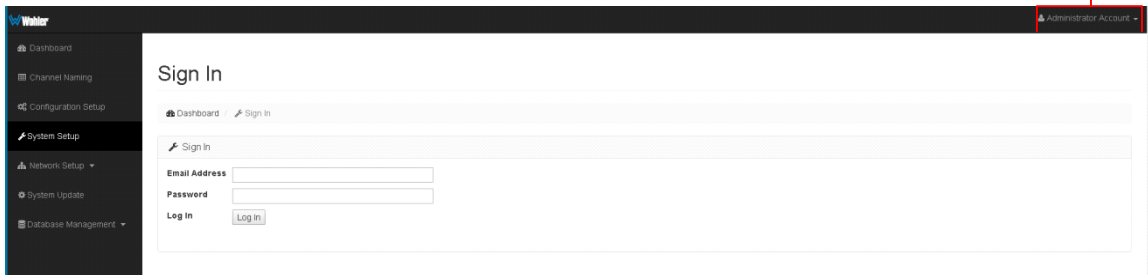

By default, the **User Name** is 'admin'.

By default, the **Password** is 'admin'.

To increase password security, refer to the **System Setup | Password Setup** section of this chapter and change the password.

You will remain logged in until the browser window is closed, the session is disconnected physically or virtually, or you **Log Out** by clicking **Administrator Account** in the upper right of any page.

**Note:** If you forget your password, you will have to perform a Factory Reset. Refer to the **Factory Reset** section of this chapter.

# Remote Monitoring

Channels from the active Preset can be monitored remotely with this selection. The channel metering will appear as shown in Figure 4-4.

Figure 4-4: Remote Monitor

*Remote Monitor Selection*

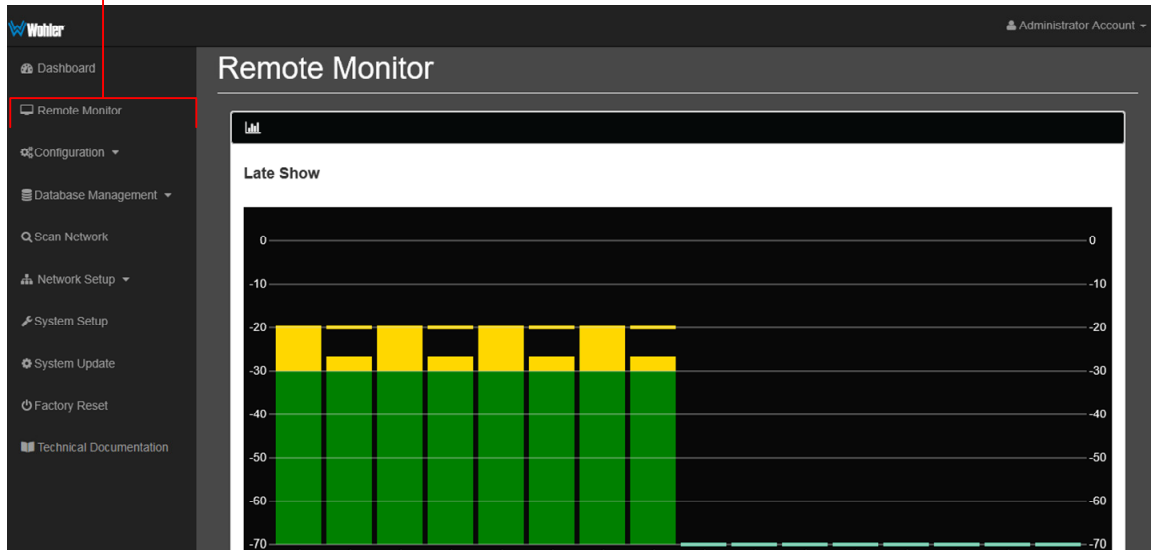



# Configuration - Preset Setup

Presets are monitoring configurations that can be composed of channels from multiple sources and displayed on the meters in any order. Presets should be set up to allow operators to quickly shift between setups for monitoring. Up to 64 Presets can be set. Any of these presets can be recalled from the Web Dashboard or from REST API's. Up to 8 Presets (in the iAM-MIX-8) or 16 Presets (in the iAM-MIX-16) can be denoted as Favorites to be displayed on the Preset Selection menu of the unit.

The **Configuration - Preset Setup** screen contains selections of all of the details for a Preset, and is largely arranged in a matrix format connecting input channels to monitoring channels. The screen shown in Figure 4-5 contains settings for 8 meters as is contained in an iAM-MIX-8. The screen for iAM-MIX-16 would show settings for 16 meters.

Figure 4-5: Configure Presets

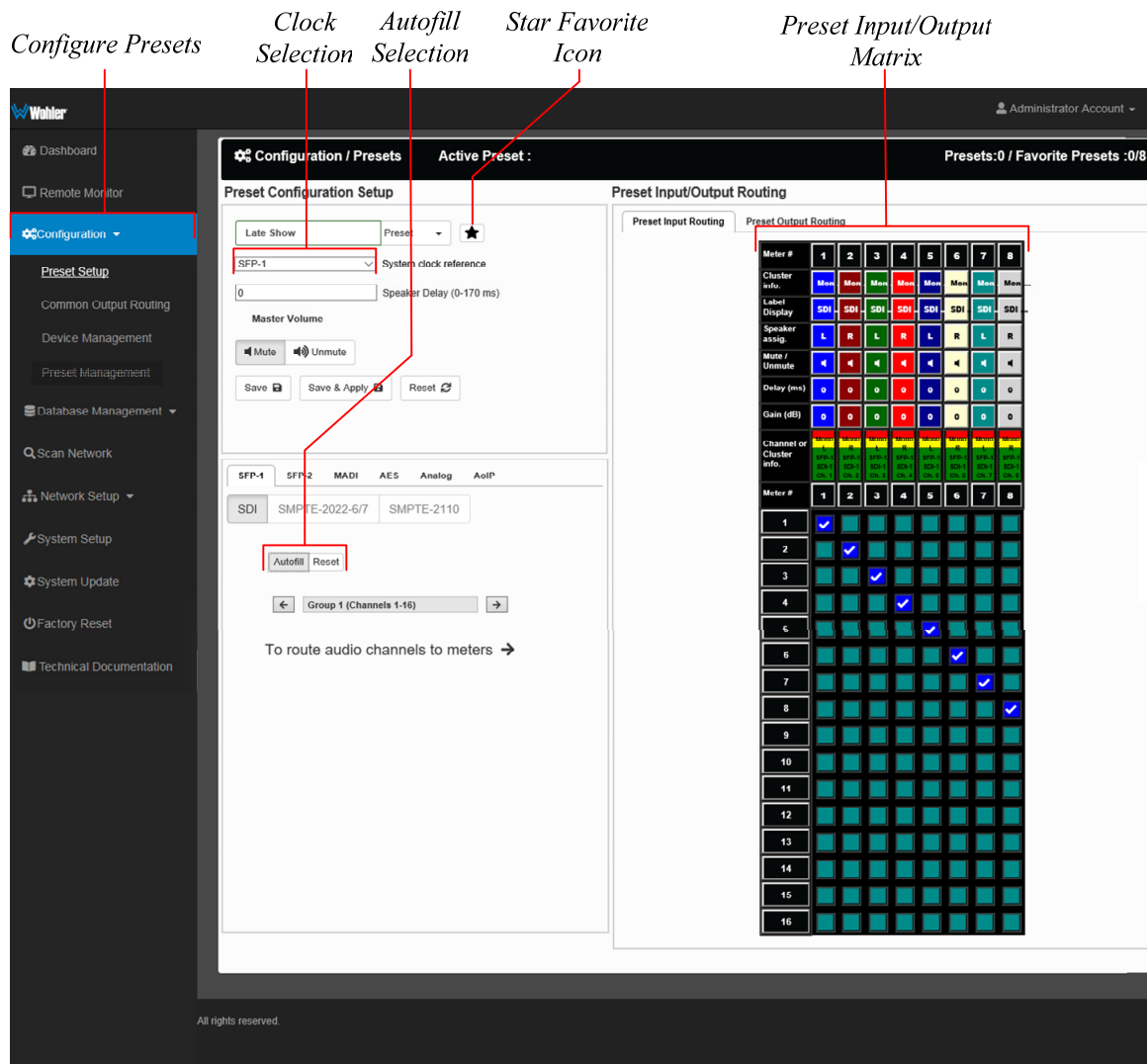

1. **Preset Configuration:** You may create a new Preset, adjust an existing Preset, or create a new Preset from an existing Preset:

- **To create a new Preset**, enter the name for the new Preset in the field to the left of the word **Preset**. Click the **Star** icon to make it a Favorite, if desired. Then make all of the settings needed and save it.
  - **To make changes to an existing Preset**, select it from the pull down list, make the needed changes and save it.
  - **To create a new Preset starting with an existing Preset**, first select the existing Preset from the pull down list. Next, enter the name for the new Preset and save it. Then make the needed changes and save it.
2. **System Clock Reference:** There must be a system clock reference for monitoring to take place. Select a reference from the pull down list. The best choice is a stable, always present clock source locked to house sync. Second to that, use the selected input as the clock. Generally speaking, **Internal** is not the best choice. An SDI or MADI stream may exhibit some audible clicks if it is not synchronized externally and is not selected as the clock reference. **A missing signal selected as the clock reference can prevent all audio from being monitored. It can also prevent the iAM-MIX integration with external routers from working.**
  3. **Speaker Delay:** If desired, an audio delay may be inserted ahead of the monitor speakers. This delay may range from 0 to 170 mS. Typically, delay is used to align the monitored audio with a video monitored signal.
  4. **Input Selection:** Audio from any of the input sources may be applied to the monitoring scheme in any way. For example, you may have 6 channels from an SDI stream, along with 2 AES channels, and along with 2 analog channels assigned your choice of meters. A **Preset Input/Output Matrix** is provided on the lower right side of the screen to allow you to assign each channel. Simply select each input source, one at a time, and then check the boxes in the **Matrix** to apply each input channel number to a metered channel number. They do not have to be applied in any specific order. The order of assignment should be chosen to make it easy for the operator to understand. If there are more than 16 channels in a source, the desired group of 8 or 16 can also be selected from the box in the lower left of the screen.
  5. **Autofill Selection:** If you simply want to map all 8 or 16 input channels to all 16 meters in the same order, click the **Autofill** button. The **Preset Input/Output Matrix** will automatically fill out. To remove all mapping, click the **Reset** button that is adjacent to the **Autofill** button.
  6. **Cluster Definition and Naming:** Only one type of Channel Cluster is available in the iAM-MIX, a Mono 1.0 cluster. Clicking a **Cluster Info** box opens a **Cluster** selection box.

Figure 4–6: Cluster Naming

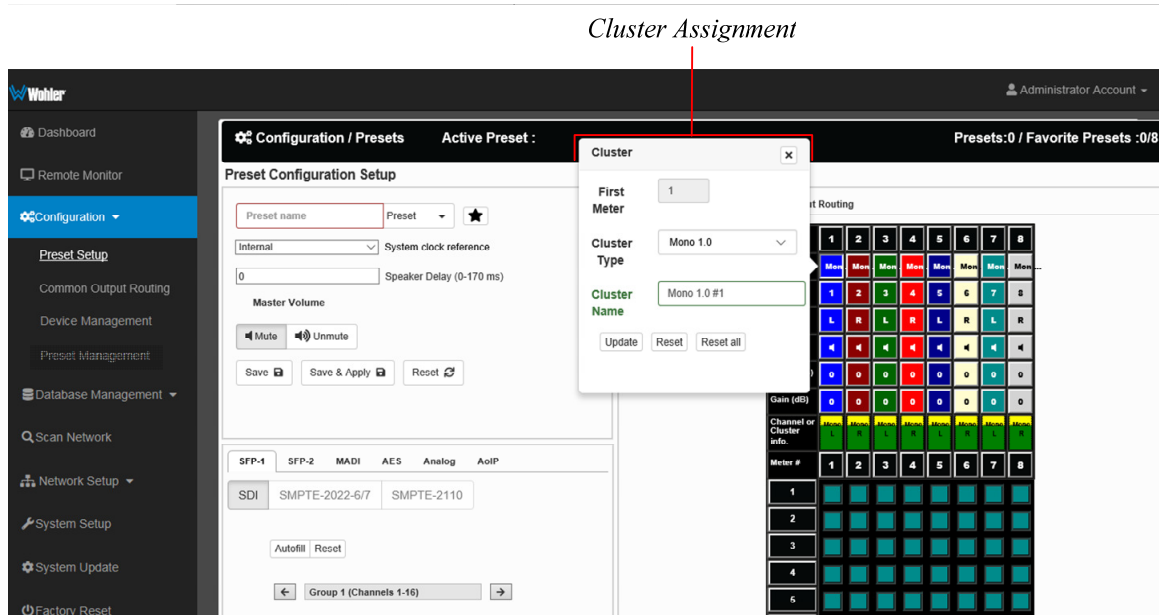

In the **Cluster Name** box, you may name the Cluster.

By default, all odd numbered channels will map to the left speakers and all even numbered channels will map to the right speakers. You may change this using the crosspoint selections in the Input/Output Matrix.

When finished, click **Update**. To undo your change, click **Reset**. To undo all of the Cluster changes for the 8 or 16 channels, click **Reset All**. Click **X** to close the box.

- Label Display:** The labels on the front panel of each channel control may be entered on this screen. You may choose top, bottom, or top and bottom labels. Each label may be up to six digits in length. When finished, click **Update**. To undo your change, click **Reset**. To undo the label changes for all of the channels, click **Reset All**. Click **X** to close the box.
- Speaker Assign:** Speaker assignments are made automatically when a cluster is set. A speaker assignment adjustment is provided for each channel, should you want to override the automatic settings. Clicking a **Speaker Assign** button on a channel opens a box that lets you change the current setting. Click **X** to close the box.
- Mute/Unmute:** A **Mute/Unmute** control is provided for each channel. This allows the operator to just see the meters for certain channels and not hear the audio. This is an alternate action control.
- Delay:** A **Delay** adjustment is provided for each channel. Clicking the **Delay** button associated with each channel opens a box that lets you set the audio delay from 0 to 42 ms. This delay is in addition to any speaker delay that is set. Enter a new value and click **OK** or click **X** to close the box.
- Gain:** A Gain adjustment is provided for each channel. Clicking the **Gain** button associated with each channel opens a box that lets you adjust the channel gain from -60 dB to +12 dB. Enter a new value and click **OK** or click **X** to close the box.

12. **Channel Information:** Hovering over each red/yellow/green **Channel or Cluster Info** box opens a summary of channel settings. You may use this to verify that you have correctly entered the needed channel settings. Refer to Figure 4-7.

Figure 4-7: Channel Summary

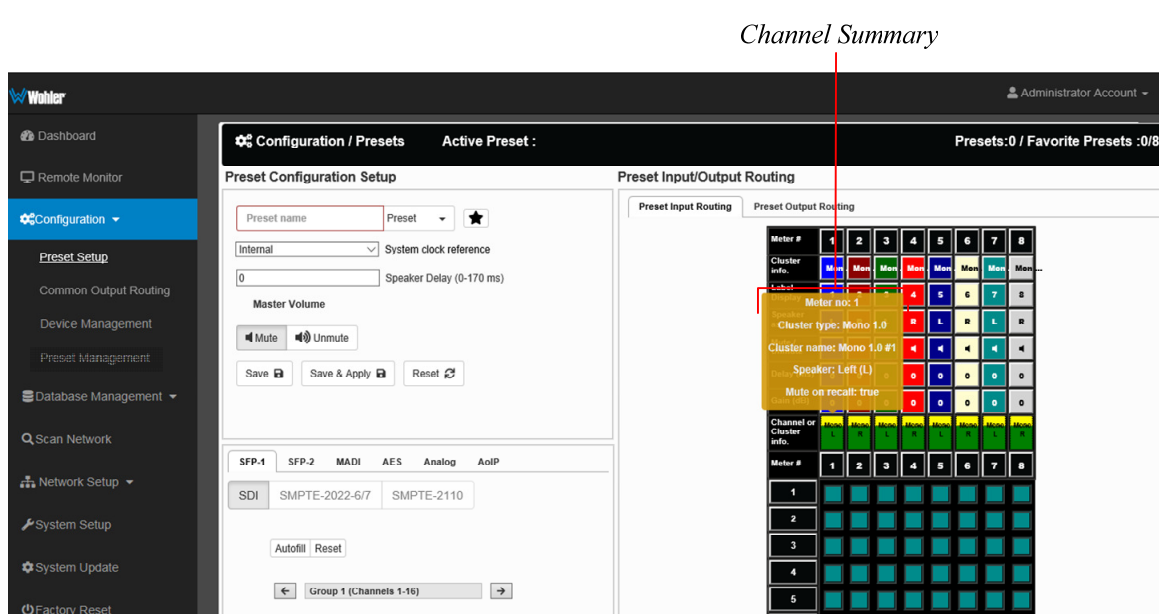

Presets may be created for any licensed inputs, even if the SFP module for an input is not plugged into its respective socket at the time. This makes it easy to swap SFP input modules without having to recreate presets after the insertion or removal of an SFP module. Note that if a licensed SFP module is not detected, such as when one is removed to be swapped, its monitoring inputs will be muted. Likewise, if the required license has not been entered for an SFP module that is inserted, its monitoring inputs will also be muted. Refer to the **System Setup** section in Chapter 4 and to Figure 4-14 to install software licenses.

13. When you have finished creating a Preset or making changes to a Preset, either click the **Save** button to save the Preset, click the **Save & Apply** button to save the Preset and make it the current Preset, or click the **Reset** button to discard the changes just made.

# Common Output Routing

The Common Output Routing licensed feature allows channels to be routed or combined and routed in custom ways to various destination outputs. Common Output routing is applied to:

1. Signals monitored using "Input Source select" from the Front Panel,
2. Presets that have been created to apply the COR.

Any change to the COR will affect the Presets that have "Apply COR" selected.

For example, multiple channels of an 7.1 channel program can be combined and directed to the left or right internal speakers. Six or eight channels could be directed to the AES outputs, which could feed an external surround sound system. Contact Wohler Sales to purchase the license for this feature.

If Common Output Routing is not licensed, then any of the iAM-MIX inputs can be monitored in stereo or mono only through the internal speakers. The headphone jack, the analog XLR outputs, and the first AES output will follow whatever is directed to the speakers.

When licensed, select Common Output Routing under Configuration. This will display the Common Output Routing (COR) screen. This screen contains a matrix which forms an easy way for you to set up the wide variety of input to output routing and mixing capabilities. The COR screen is shown in Figure 4-8.

Figure 4-8: Common Output Routing (COR) Screen

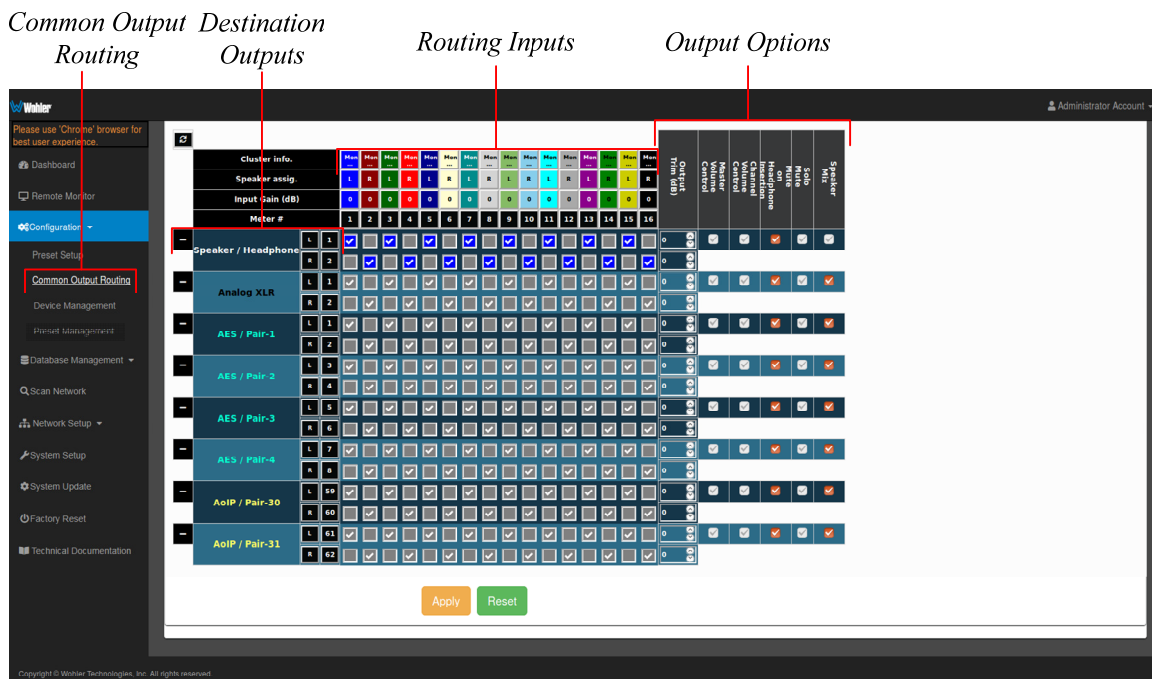

## Destination Outputs

On the left of the COR screen are listed the Destination Outputs. These are the outputs to which any input can be routed. They are as follows:

1. **Speaker/Headphone:** Selected inputs will be sent to the left and right

speakers. The default routing is set as per the Speaker Assignment, left channels are sent to the left speaker and right channels are sent to Right speaker.

2. **Analog XLR:** Selected inputs will be mixed to the left and right channels and played through the two Analog XLR Outputs.
3. **AES/Pair-1:** Selected inputs will be mixed to the left and right channels and played through the AES Pair 1 Output.
4. **AES/Pair-2:** Selected inputs will be mixed to the left and right channels and played through the AES Pair 2 Output.
5. **AES/Pair-3:** Selected inputs will be mixed to the left and right channels and played through the AES Pair 3 Output.
6. **AES/Pair-4:** Selected inputs will be mixed to the left and right channels and played through the AES Pair 4 Output. The four AES outputs can be used together to output, for example, 5.1 or 7.1 surround channels to an external surround sound monitor system.
7. **AoIP/Pair-30 (DANTE / RAVENNA):** Selected inputs will be mixed to AoIP transmit channels 59 and 60. Note that configuration for channels 1 - 58 is not supported. Use a Dante Controller or Coveloz web interface to route these channels appropriately.
8. **AoIP/Pair-31 (DANTE / RAVENNA):** Selected inputs will be mixed to Channel 61 and Channel 62. Again, use a Dante Controller or Coveloz web interface to route the remaining pairs appropriately.

## Routing Inputs

The inputs which may be routed are described in this section.

1. **Cluster Information:** Cluster information show type of cluster and cluster name. iAmMix currently only supports Mono clusters.
2. **Speaker Assignment :** Speaker assignment can be used to configure to which speakers the audio is routed to. The possible options are:
  - L** Left
  - R** Right
  - C** Center
  - LFE** Low Frequency Effects
  - Ls** Left Surround
  - Rs** Right Surround
  - Bsl** Back Surround Left
  - Bsr** Back Surround Right
  - S** Mono Surround
3. **Input Gain (dB):** Settings from -60 dB to +12 dB in 1 dB increments to allow for differences in gain between speakers in a set.

## Output Options

The optional settings in this section allow for customization.

1. **Speaker Mix:** This option selects whether an output has the **Speaker Mix** or a **Free Mix** as set in the Routing Input section. The Speaker/Headphone output is always in the **Speaker Mix**.
2. **Solo/Mute:** This setting determines whether or not the outputs are affected by solos and mutes. The Speaker/Headphone output is always affected by solos and mutes. Note also, that all outputs in **Speaker Mix** mode also are affected by solos and mutes.
3. **Mute on Headphone Insertion:** This option controls whether the outputs should be muted upon a headphone insertion. This setting can be adjusted even for outputs whether they are in **Speaker Mix** or **Free Mix** modes.
4. **Master Volume Control:** This setting determines whether each output pair is adjusted by the **Master Volume Control** knobs. Speaker/Headphone outputs are always affected by the volume control knob, as are any outputs that are in **Speaker Mix** mode.
5. **Channel Volume Control:** This setting determines whether each output pair is adjusted by the **Channel Volume Control** knobs. Speaker/Headphone outputs are always affected by the volume control knob, as are any outputs that are in **Speaker Mix** mode.
6. **Output Trim:** The gain of each output channel can be adjusted from -60 dB to +12 dB in 1 dB increments to allow for differences between speakers in a set. Output level trims are always available for each output, regardless of whether they are in **Speaker Mix** or **Free Mix** mode.







# Typical Questions Regarding Output Routing

The questions and thoughts in this section are commonly asked by people when setting up the licensed Output Routing capability.

## How do I route sources being audibly monitored to the XLR and AES outputs?

Using Preset Output Routing or Common Output Routing, signals can be routed to XLR and/or AES outputs, possibly to be monitored by external speakers.

In Figure 4-10, signals displayed on meters 1 through 8 are routed pair wise to AES Pair 1 and signals displayed on meters 9 through 16 are routed pair wise to the Analog XLR outputs.

Figure 4-10 - Output Routing to AES and Analog Outputs

		Meter #		1	2	3	4	5	6	7	8	9	10	11	12	13	14	15	16	
+		L	1	Speaker / Headphone																0
-	Analog XLR		1																	
		2																		
-	AES / Pair-1		1																	
		2																		

## How do I output pre-fade signals on one output and post-fade outputs on another?

For example, to output downmixed pre-fade audio signals on AES Pair-1, keep the associated Master and Channel Volume Controls OFF (unchecked). Or, to output post-fade audio signals on the Analog XLR, keep the associated Master and Channel Volume Controls ON (checked). Figure 4-11 shows both of these setups.

Figure 4-11 - Output Routing of Pre-Fade and Post-Fade Audio

		Meter #		1	2	3	4	5	6	7	8	9	10	11	12	13	14	15	16						
+		L	1	Speaker / Headphone																0					
-	Analog XLR		1																						
		2																							
-	AES / Pair-1		1																						
		2																							

## How do I make some outputs follow Mutes and Solos while making other outputs ignore them?

In the example shown in Figure 4-12, the Analog XLR Outputs will follow Solos and Mutes, while AES Pair 1 will ignore them. Simple check or uncheck the Solo/Mute selection in the Output Options section.

Figure 4-12 - Applying Solos and Mutes to Output Routing

Cluster info.		Mon	Mon	Mon	Mon	Mon	Mon	Mon	Mon	Mon	Mon	Mon	Mon	Mon	Mon	Mon	Mon	Output Trim (dB)	Master Volume Control	Channel Volume Control	Mute on Headphone Insertion	Solo Mute	Speaker Max	
Speaker assig.		L	R	L	R	L	R	L	R	L	R	L	R	L	R	L	R							
Input Gain (dB)		0	0	0	0	0	0	0	0	0	0	0	0	0	0	0	0							
Meter #		1	2	3	4	5	6	7	8	9	10	11	12	13	14	15	16							
+	Speaker / Headphone	L	1															0	<input checked="" type="checkbox"/>	<input checked="" type="checkbox"/>	<input checked="" type="checkbox"/>	<input checked="" type="checkbox"/>	<input checked="" type="checkbox"/>	
		R	1																0	<input type="checkbox"/>	<input type="checkbox"/>	<input type="checkbox"/>	<input checked="" type="checkbox"/>	<input type="checkbox"/>
-	Analog XLR	L	1															0	<input type="checkbox"/>	<input type="checkbox"/>	<input type="checkbox"/>	<input type="checkbox"/>	<input type="checkbox"/>	
		R	2																0	<input type="checkbox"/>	<input type="checkbox"/>	<input type="checkbox"/>	<input type="checkbox"/>	<input type="checkbox"/>
-	AES / Pair-1	L	1	<input checked="" type="checkbox"/>	<input checked="" type="checkbox"/>	<input checked="" type="checkbox"/>	<input checked="" type="checkbox"/>	<input checked="" type="checkbox"/>	<input checked="" type="checkbox"/>	<input checked="" type="checkbox"/>	<input checked="" type="checkbox"/>	<input checked="" type="checkbox"/>	<input checked="" type="checkbox"/>	<input checked="" type="checkbox"/>	<input checked="" type="checkbox"/>	<input checked="" type="checkbox"/>	<input checked="" type="checkbox"/>	0	<input type="checkbox"/>	<input type="checkbox"/>	<input type="checkbox"/>	<input type="checkbox"/>	<input type="checkbox"/>	
		R	2	<input checked="" type="checkbox"/>	<input checked="" type="checkbox"/>	<input checked="" type="checkbox"/>	<input checked="" type="checkbox"/>	<input checked="" type="checkbox"/>	<input checked="" type="checkbox"/>	<input checked="" type="checkbox"/>	<input checked="" type="checkbox"/>	<input checked="" type="checkbox"/>	<input checked="" type="checkbox"/>	<input checked="" type="checkbox"/>	<input checked="" type="checkbox"/>	<input checked="" type="checkbox"/>	<input checked="" type="checkbox"/>	0	<input type="checkbox"/>	<input type="checkbox"/>	<input type="checkbox"/>	<input type="checkbox"/>	<input type="checkbox"/>	

## How do I route only specific monitored channels to the Analog XLR outputs?

Using Output Routing, certain selected channels may be routed to any chosen outputs. In Figure 4-13, channels monitored on meters 9 to 16 are combined and routed to the Analog XLR outputs.

Figure 4-13 - Specific Channel Output Routing

Cluster info.		Mon	Mon	Mon	Mon	Mon	Mon	Mon	Mon	Mon	Mon	Mon	Mon	Mon	Mon	Mon	Output Trim (dB)	Master Volume Control	Channel Volume Control	Mute on Headphone Insertion	Solo Mute	Speaker Max		
Speaker assig.		L	R	L	R	L	R	L	R	L	R	L	R	L	R	L	R							
Input Gain (dB)		0	0	0	0	0	0	0	0	0	0	0	0	0	0	0	0							
Meter #		1	2	3	4	5	6	7	8	9	10	11	12	13	14	15	16							
+	Speaker / Headphone	L	1															0	<input checked="" type="checkbox"/>	<input checked="" type="checkbox"/>	<input checked="" type="checkbox"/>	<input checked="" type="checkbox"/>	<input checked="" type="checkbox"/>	
		R	1																0	<input checked="" type="checkbox"/>	<input type="checkbox"/>	<input type="checkbox"/>	<input type="checkbox"/>	<input type="checkbox"/>
-	Analog XLR	L	1															0	<input type="checkbox"/>	<input type="checkbox"/>	<input type="checkbox"/>	<input type="checkbox"/>	<input type="checkbox"/>	
		R	2																0	<input type="checkbox"/>	<input type="checkbox"/>	<input type="checkbox"/>	<input type="checkbox"/>	<input type="checkbox"/>

## How do I configure outputs for Source Select options, without creating Presets?

Use the Common Output Routing settings to determine how the outputs are configured for source select options. The Common Output Routing feature allows channels to be routed or combined and routed to various destinations. For example, channels 1 to 8 can be routed to AES outputs, channels 9 to 16 can be routed to Analog XLR outputs. Figure 4-14 shows the various outputs that channels can be routed to from selected sources.



## How do I ensure that outputs get automatically muted when a headphone is inserted into the headphone jack?

In Output Routing configuration, if the Mute on Headphone Insertion selection in the Output Options is ON (checked), then the outputs get automatically muted when a headphone jack is inserted into the headphone jack. In Figure 4-16, AES Pair 1 will be muted when a headphone is inserted, but the Analog XLR outputs will not.

Figure 4-16 - Headphone Insertion Muting Effect on Output Routing

Cluster info.	Mon	Mon	Mon	Mon	Mon	Mon	Mon	Mon	Mon	Mon	Mon	Mon	Mon	Mon	Mon	Mon	Output Trim (dB)	Master Volume Control	Channel Volume Control	Mute on Headphone Insertion	Solo Mute	Speaker Mix
Speaker assig.	L	R	L	R	L	R	L	R	L	R	L	R	L	R	L	R						
Input Gain (dB)	0	0	0	0	0	0	0	0	0	0	0	0	0	0	0	0						
Meter #	1	2	3	4	5	6	7	8	9	10	11	12	13	14	15	16						
Speaker / Headphone																	0	<input checked="" type="checkbox"/>	<input checked="" type="checkbox"/>	<input checked="" type="checkbox"/>	<input checked="" type="checkbox"/>	<input checked="" type="checkbox"/>
Analog XLR	L	1	<input checked="" type="checkbox"/>	<input checked="" type="checkbox"/>	<input checked="" type="checkbox"/>	<input type="checkbox"/>	<input type="checkbox"/>	<input type="checkbox"/>	<input type="checkbox"/>	<input type="checkbox"/>	<input type="checkbox"/>	<input type="checkbox"/>	<input type="checkbox"/>	<input type="checkbox"/>	<input type="checkbox"/>	<input type="checkbox"/>	0	<input checked="" type="checkbox"/>	<input type="checkbox"/>	<input type="checkbox"/>	<input type="checkbox"/>	<input type="checkbox"/>
	R	2	<input type="checkbox"/>	<input checked="" type="checkbox"/>	<input type="checkbox"/>	<input checked="" type="checkbox"/>	<input type="checkbox"/>	<input type="checkbox"/>	<input type="checkbox"/>	<input type="checkbox"/>	<input type="checkbox"/>	<input type="checkbox"/>	<input type="checkbox"/>	<input type="checkbox"/>	<input type="checkbox"/>	<input type="checkbox"/>	0	<input checked="" type="checkbox"/>	<input type="checkbox"/>	<input type="checkbox"/>	<input type="checkbox"/>	<input type="checkbox"/>
AES / Pair-1	L	1	<input type="checkbox"/>	<input type="checkbox"/>	<input type="checkbox"/>	<input type="checkbox"/>	<input type="checkbox"/>	<input checked="" type="checkbox"/>	<input type="checkbox"/>	<input type="checkbox"/>	<input type="checkbox"/>	<input type="checkbox"/>	<input type="checkbox"/>	<input type="checkbox"/>	<input type="checkbox"/>	<input type="checkbox"/>	0	<input checked="" type="checkbox"/>	<input type="checkbox"/>	<input checked="" type="checkbox"/>	<input type="checkbox"/>	<input type="checkbox"/>
	R	2	<input type="checkbox"/>	<input type="checkbox"/>	<input type="checkbox"/>	<input type="checkbox"/>	<input type="checkbox"/>	<input checked="" type="checkbox"/>	<input type="checkbox"/>	<input type="checkbox"/>	<input type="checkbox"/>	<input type="checkbox"/>	<input type="checkbox"/>	<input type="checkbox"/>	<input type="checkbox"/>	<input type="checkbox"/>	0	<input checked="" type="checkbox"/>	<input type="checkbox"/>	<input type="checkbox"/>	<input type="checkbox"/>	<input type="checkbox"/>

## Why are AES Pairs 1, 2, 3, and 4 in the Output Routing Matrix?

If channels are to be monitored using a multichannel external sound system, then the multiple AES Outputs can be used to output 6 or 8 channels to it. Using the output routing matrix, check the channels to be monitored on each of the AES Outputs. This will route the audio channels to the AES Outputs on the rear panel.

## What are AoIP-Pair 30 and AoIP Pair 31?

Figure 4-14 shows the AoIP Output channels in the Output Matrix. They perform the following functions:

**AoIP-Pair 30:** Selected inputs will be mixed to AoIP transmit channels 59 and 60. Note that configuration for channels 1 - 58 is not supported. Use a Dante Controller or Covelloz web interface to route these channels appropriately.

**AoIP-Pair 31:** Selected inputs will be mixed to Channel 61 and Channel 62. Again, use a Dante Controller or Covelloz web interface to route the remaining pairs appropriately.

## How do I route signals to the Analog XLR Outputs in a way that Master Volume doesn't affect this output but Channel Volume and Mute/Solo does?

In Output Routing setting for the Analog XLR outputs, set the Master Volume Control to OFF (unchecked) but set the Channel Volume Control & Solo/Mute to ON (checked). This is illustrated in Figure 4-17.

Figure 4-17 - Effect of Master Volume and Solo/Mute Settings on Outputs

Cluster info.	Mon	Mon	Mon	Mon	Mon	Mon	Mon	Mon	Mon	Mon	Mon	Mon	Mon	Mon	Mon	Mon	Output Trim (dB)	Master Volume Control	Channel Volume Control	Mute on Headphone Insertion	Solo Mute	Speaker Mix
Speaker assig.	L	R	L	R	L	R	L	R	L	R	L	R	L	R	L	R	0	<input type="checkbox"/>	<input checked="" type="checkbox"/>	<input checked="" type="checkbox"/>	<input checked="" type="checkbox"/>	<input checked="" type="checkbox"/>
Input Gain (dB)	0	0	0	0	0	0	0	0	0	0	0	0	0	0	0	0	0	<input type="checkbox"/>	<input checked="" type="checkbox"/>	<input type="checkbox"/>	<input checked="" type="checkbox"/>	<input type="checkbox"/>
Meter #	1	2	3	4	5	6	7	8	9	10	11	12	13	14	15	16	0	<input type="checkbox"/>	<input checked="" type="checkbox"/>	<input type="checkbox"/>	<input checked="" type="checkbox"/>	<input type="checkbox"/>

Channel volume control is applied but Master Volume Control is not applied.

Solo/Mute is applied for Analog XLR outputs.

## How do I make Channel Volume, but not Mutes or Solos, affect the output?

In Output Routing setting, for the chosen output, set the Master Volume Control and Solo/Mute to OFF (unchecked) and set the Channel Volume Control to ON (checked). This is illustrated in Figure 4-18 for the Analog XLR outputs.

Figure 4-18 - Effect of Channel Volume on Outputs

Cluster info.	Mon	Mon	Mon	Mon	Mon	Mon	Mon	Mon	Mon	Mon	Mon	Mon	Mon	Mon	Mon	Mon	Output Trim (dB)	Master Volume Control	Channel Volume Control	Mute on Headphone Insertion	Solo Mute	Speaker Mix
Speaker assig.	L	R	L	R	L	R	L	R	L	R	L	R	L	R	L	R	0	<input type="checkbox"/>	<input checked="" type="checkbox"/>	<input type="checkbox"/>	<input type="checkbox"/>	<input type="checkbox"/>
Input Gain (dB)	0	0	0	0	0	0	0	0	0	0	0	0	0	0	0	0	0	<input type="checkbox"/>	<input checked="" type="checkbox"/>	<input type="checkbox"/>	<input type="checkbox"/>	<input type="checkbox"/>
Meter #	1	2	3	4	5	6	7	8	9	10	11	12	13	14	15	16	0	<input type="checkbox"/>	<input checked="" type="checkbox"/>	<input type="checkbox"/>	<input type="checkbox"/>	<input type="checkbox"/>

Only Channel Volume Control is applied.

# Configuration – Device Management

This page is used to manage integration with Grass Valley systems to automatically set the text in the labels on the channel strips. Grass Valley integration can be used for AES and SDI audio monitoring interfaces.

Evertz and Tally integrations do not require any setup. They are used for the MADI audio monitoring interface.

Figure 4–19: Device Management

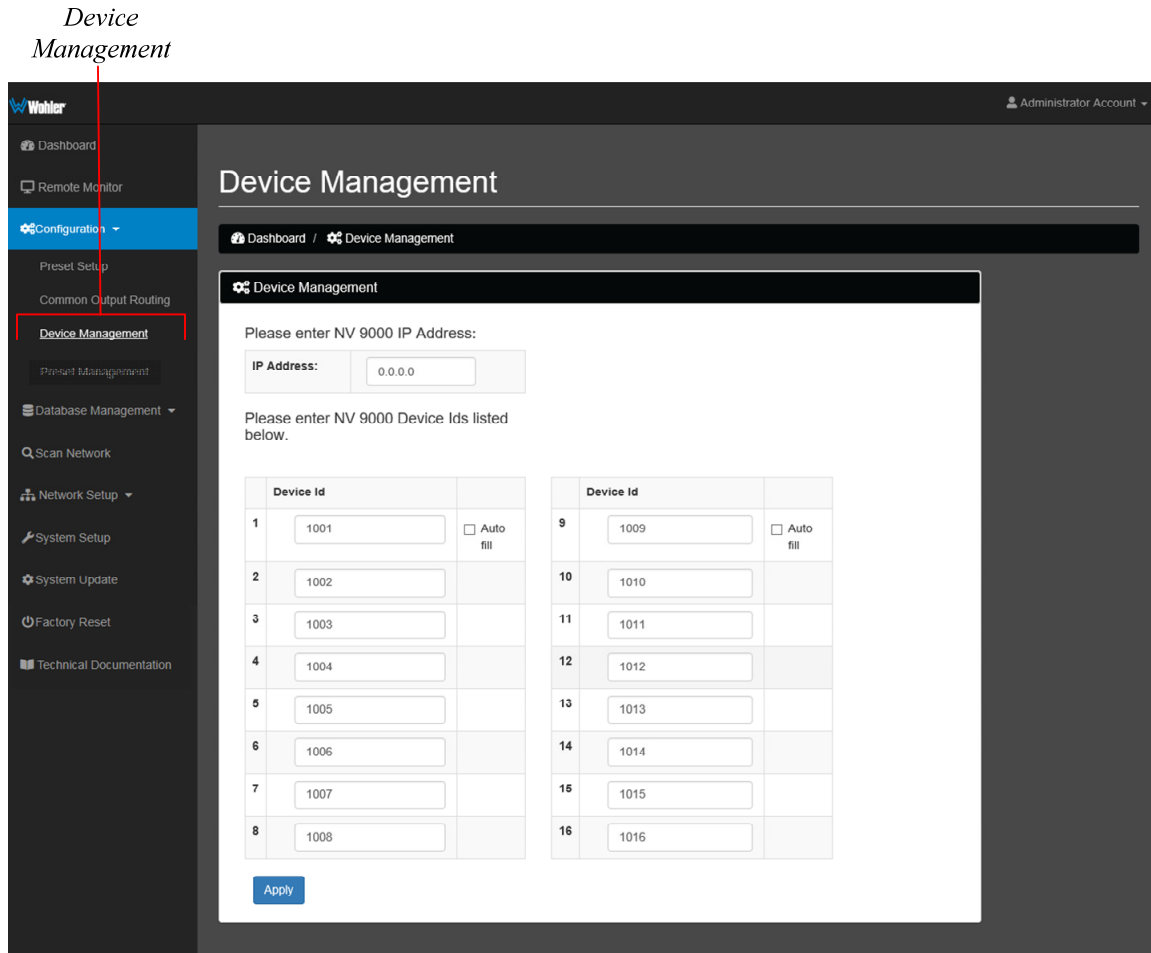

To set up Grass Valley integration, use the following steps:

1. Enter the network address of the Grass Valley NV9000 router control system in the **IP Address** box as shown in Figure 4-8.
2. Enter channel number to be routed in **Device ID** field.
3. Check the **Auto fill** box. This will fill all of the other **Device ID** fields automatically and incrementally.
4. Click the **Apply** button at the bottom of the page.

Check that the required **Clock Reference** is checked on the **Configuration - Setup** page. If there is no clock reference, the integration cannot work.

# Configuration – Preset Management

The Web GUI of the iAM-MIX makes it easy to manage multiple iAM-MIX units on a network from a single location. The Preset Management page is used to copy Presets from either this iAM-MIX or from a file on the host PC to one or more other iAM-MIX units on the network. Having the same Presets on multiple iAM-MIX units allows operators to move from unit to unit without having to deal with any setup differences in each unit. The Preset Management page is shown in Figure 4-20.

Figure 4–20: Preset Management

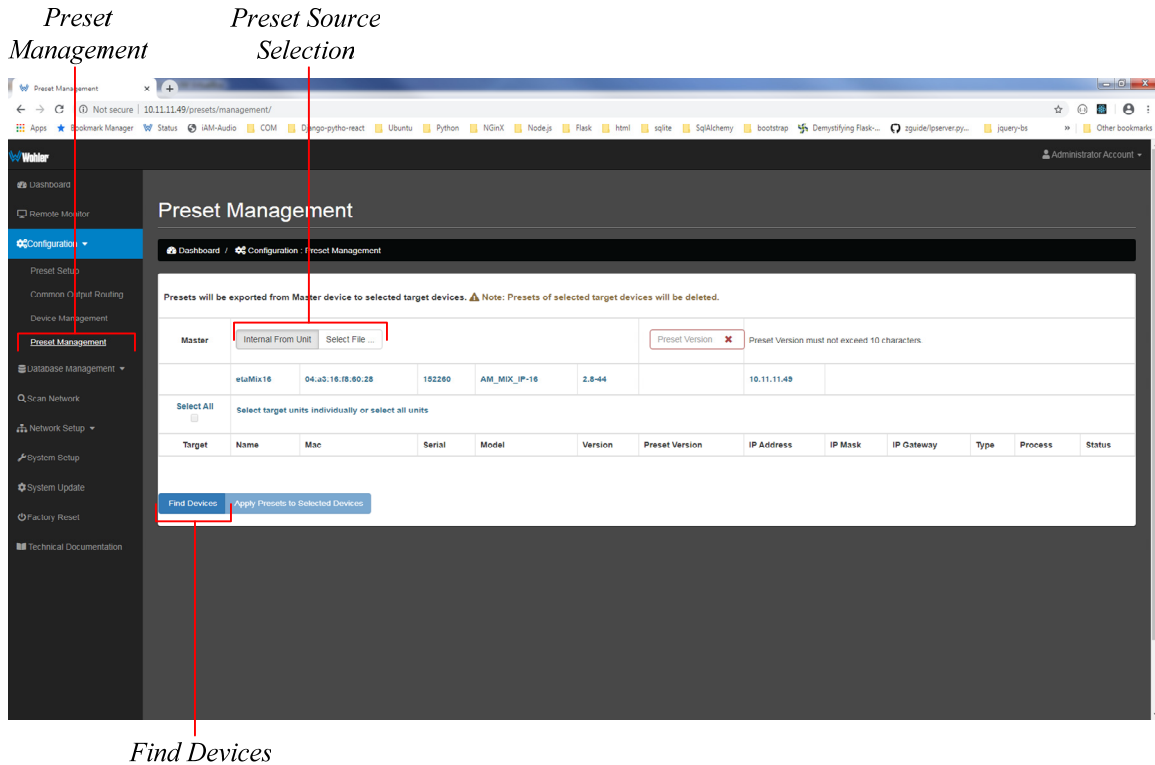

To copy the Presets in the iAM-MIX being accessed from the Web GUI (the Source or Master Unit) or Presets in files in the PC accessing the Web GUI to other iAM-MIX units on the network, use the following steps:

1. Select the source of the Presets to be copied by clicking either the **Internal From Unit** or the **Select File** button.
2. Click the **Find Devices** button to locate other iAM-MIX units on the network. After scanning the network, the units found will be listed in the Target column.
3. **Note that the existing Presets on the unit(s) receiving the copied Presets will be deleted.**
4. Proceed to either the **Copying Presets from this Unit** section or the **Copying Presets from Files** section which follow.



## Copying Presets from this Unit

After the list of iAM-MIX units on the network has appeared, the screen shown in Figure 4-21 will appear. Using this screen, you may select which of the units on the network should receive the copies of the Presets.

Figure 4-21: Preset Management

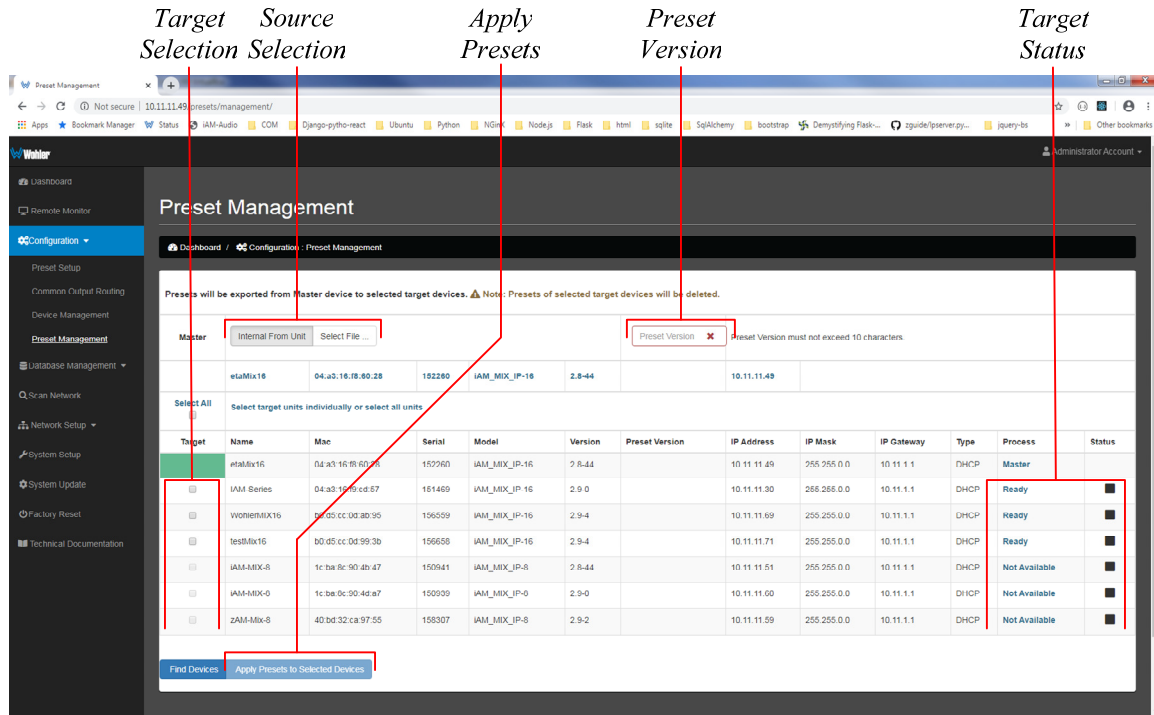

To copy the Presets from the Master Unit to other iAM-MIX units on the network, use the following steps:

1. Click **Internal from Unit** from the Source Selection buttons.
2. Enter a version name in the Preset Version field shown in Figure 4-21.
3. In the Target Selection column, check the box of each iAM-MIX to receive the Presets.
4. After selecting one or more units, click the **Apply Presets to Selected Devices** button. A confirmation box will pop up. Click **Apply Presets** in that box.
5. As the Preset copying proceeds, the Process and Status boxes will show the progress as follows:

Process	Status
Copying files	⚙️
Validating file	✅
Loading Presets	⚙️
Finished	✅
Error copying presets	❌



## Copying Presets from Files

After the list of iAM-MIX units on the network has appeared, the screen shown in Figure 4-22 will appear. Using this screen, you may select which of the units on the network should receive the copies of the Presets.

Figure 4-22: Preset Management

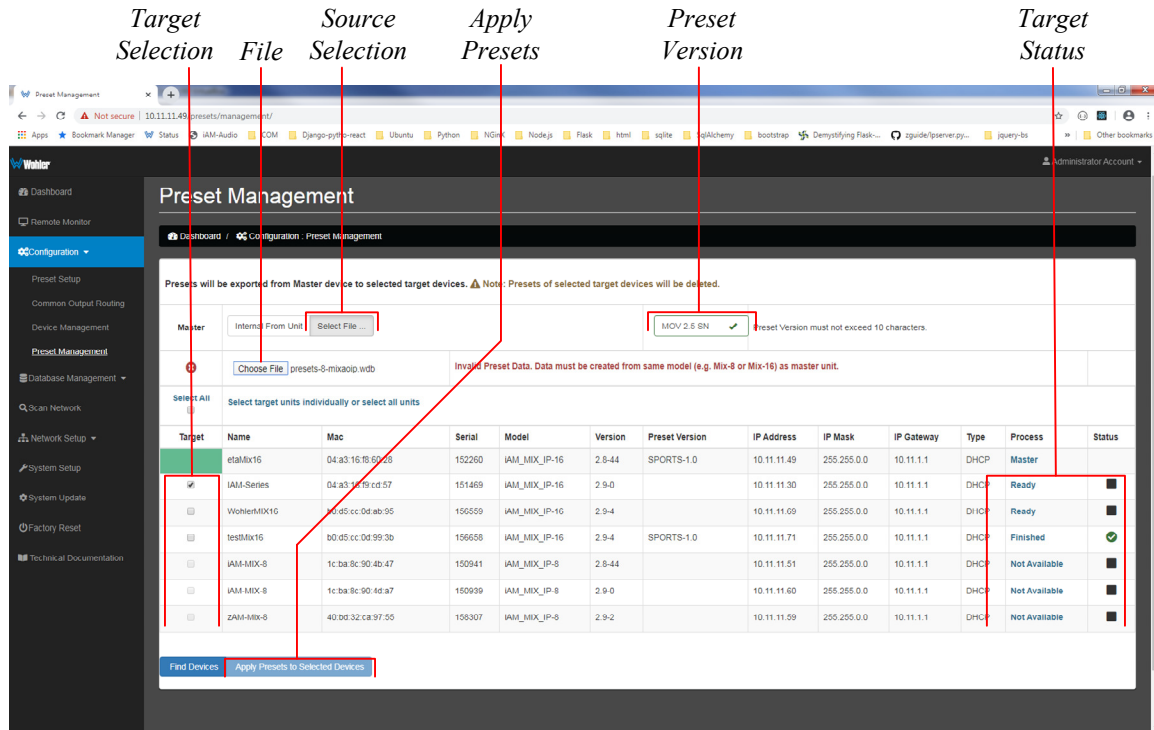

To copy the Presets from a file to other iAM-MIX units on the network, use the following steps:

1. Click **Select File** from the Source Selection buttons.
2. Enter a version name in the Preset Version field shown in Figure 4-22.
3. Use the Choose File button to select the file you would like to copy to other iAM-MIX units.
4. In the Target Selection column, check the box of each iAM-MIX to receive the Presets.
5. After selecting one or more units, click the **Apply Presets to Selected Devices** button. A confirmation box will pop up. Click **Apply Presets** in that box.
6. As the Preset copying proceeds, the Process and Status boxes will show the progress as follows:

Process	Status
Copying files	
Validating file	
Loading Presets	
Finished	
Error copying presets	

## Dirty Presets

Whenever any changes on a Preset are done locally, the Preset is labeled as "Dirty". An example of this is shown in Figure 4-23. This means that this Preset is no longer exactly the same as it was when it was applied to that particular iAM-MIX. It is a reminder that if you are going to copy it to other units, you should be certain that it is the one you actually want to copy.

Figure 4-23: Dirty Presets

*Dirty Preset*

Target	Name	Mac	Serial	Model	Version	Preset Version	IP Address	IP Mask	IP Gateway	Type	Process	Status
	etAMix16	04:a3:16:18:60:28	152280	iAM_MIX_IP-16	2.8-44	MOV 2.5 SN-dirty	10.11.11.49	255.255.0.0	10.11.1.1	DHCP	Master	
	iAM Series	04:a3:16:19:cd:87	161489	iAM_MIX_IP-16	2.9.0	MOV 2.5 8N	10.11.11.30	255.255.0.0	10.11.1.1	DHCP	Ready	
	WorNetMIX16	00:00:00:00:00:00	106059	iAM_MIX_IP-16	2.9-4	MOV 2.5 SN	10.11.11.69	255.255.0.0	10.11.1.1	DHCP	Ready	
	testMIX16	b0:d5:cc:0d:99:3b	156658	iAM_MIX_IP-16	2.9-4	SPORTS-1.0	10.11.11.71	255.255.0.0	10.11.1.1	DHCP	Ready	
	iAM-MIX-S	1c:ba:8c:90:4d:a7	150939	iAM_MIX_IP-S	2.9-0		10.11.11.60	255.255.0.0	10.11.1.1	DHCP	Not Available	
	iAM-MIX-0	1c:ba:8c:90:4b:47	150941	iAM_MIX_IP-0	2.9-44		10.11.11.51	255.255.0.0	10.11.1.1	DHCP	Not Available	
	zAM-MIX-S	40:bd:32:ca:97:55	158307	iAM_MIX_IP-S	2.9-2		10.11.11.59	255.255.0.0	10.11.1.1	DHCP	Not Available	

To remove the suffix "Dirty" from an iAM-MIX Preset setup and correct its Preset setup, simply copy a fresh set of Presets from another unit that is not labeled "Dirty".

# Database Management

## Export Presets

Use this page to offload an iAM-MIX Preset database to a USB flash drive, inserted in the front panel port. Follow the instructions on the bottom of the page to complete the procedure.

Figure 4–24: Export Presets

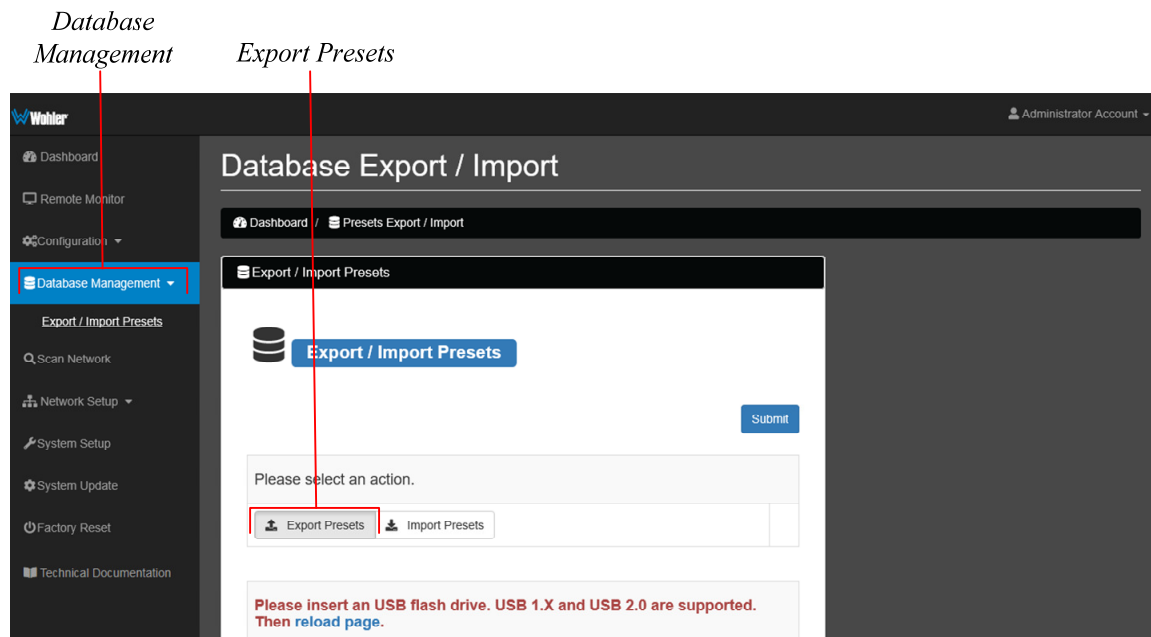

Use the following steps:

1. Click the **Export Presets** button on the **Database Management - Database Export / Import** page.
2. Insert a flash drive in the front panel USB jack on the iAM-MIX you want to back up.
3. Click the blue **reload page** link at the bottom of the page. The Preset data will be written onto the Flash Drive. Do not withdraw the Flash Drive before all of the data is written to it.

These instructions are summarized on the **Database Management - Database Export / Import** page.

## Import Presets

Use this page to retrieve Presets from a USB flash drive inserted in the front panel port. Follow the instructions on the bottom of the page to complete the procedure.

Figure 4–25: Preset Import

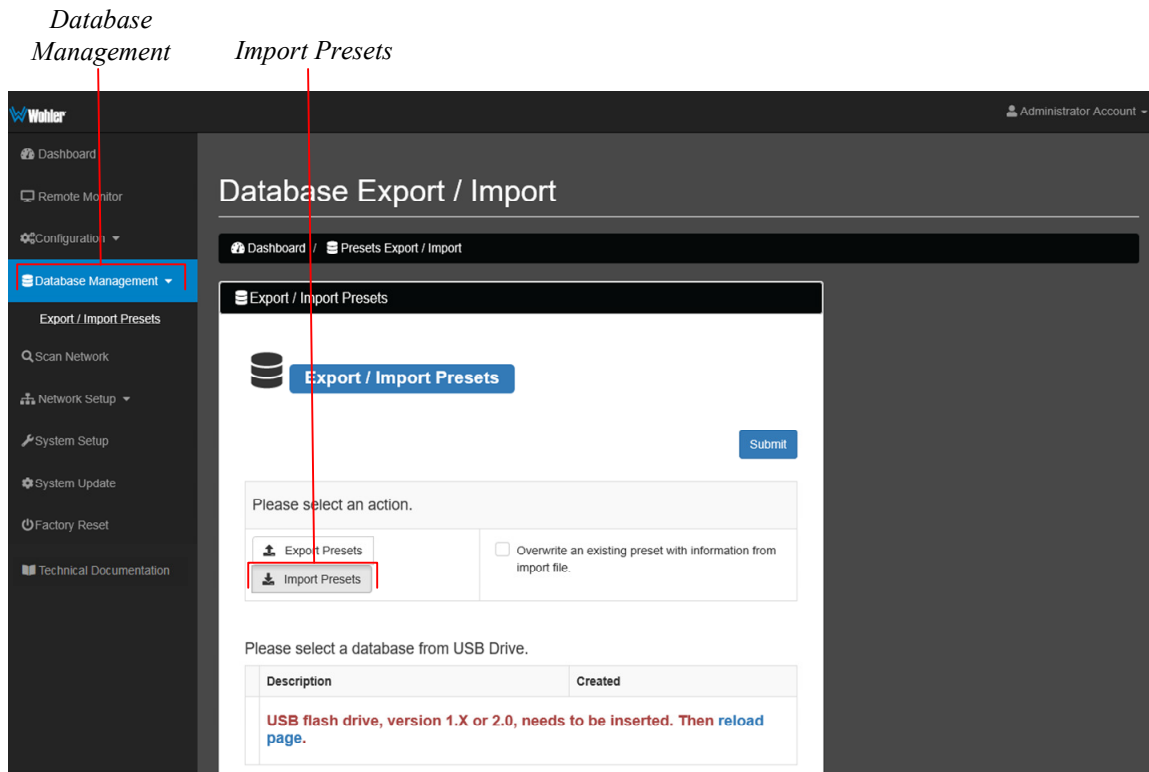

Use the following steps:

1. Click the **Import Presets** button on the **Database Management - Database Export / Import** page.
2. Insert a flash drive in the front panel USB jack on the iAM-MIX you want to recover Preset data from.
3. Click the blue **reload page** link at the bottom of the page. The list of Preset databases that are contained on the Flash Drive will appear on the screen.
4. Select a Preset database from the list. The Preset data you selected will be copied into the iAM-MIX. Do not withdraw the Flash Drive before all of the data is copied.

These instructions are summarized on the **Database Management - Database Export / Import** page.

# Scan Network-Discovery

This page will scan the network for Wohler iAM monitors installed on the network. Other devices can have their network settings reconfigured by clicking the Edit (pencil) icon. Information about the **Updates** tab is in [Installing Software on Networked iAM-MIXs](#).

Figure 4–26: Active Device Discovery

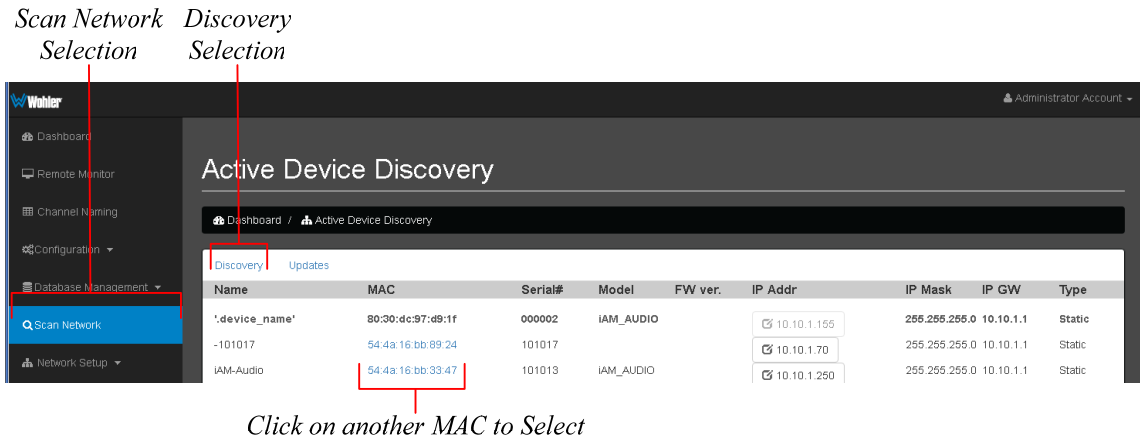

# Network Setup

Make network **IP Address** changes for the **Management (MGMT) Port** on the local iAM-MIX using this screen.

Figure 4–27: Set IP Addresses

*Network Setup –  
Set IP Addresses  
Selection*

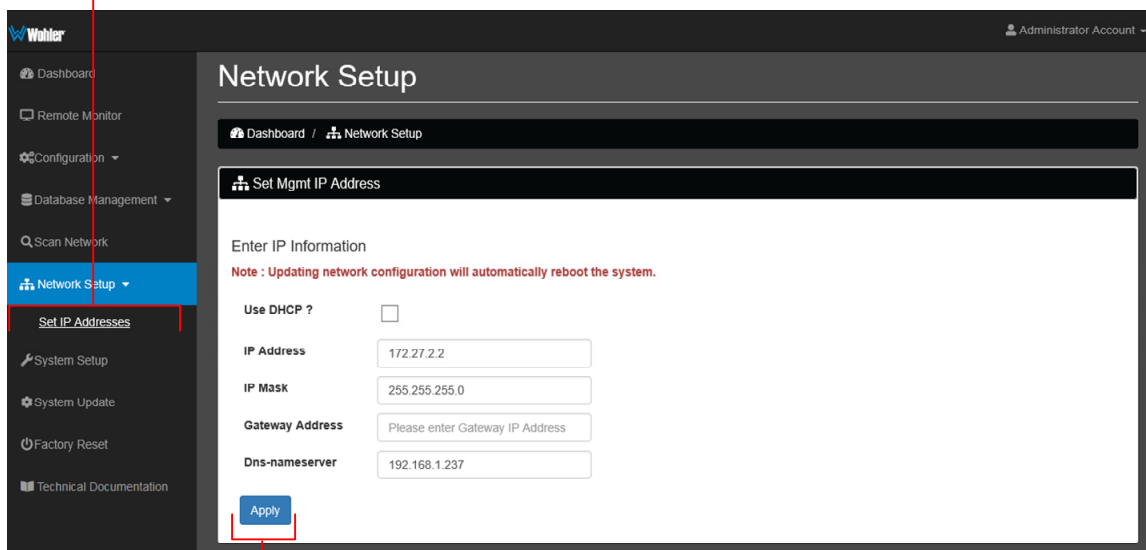

*Click to Apply new address and reboot iAM-MIX*

The procedure for changing the IP Address information is as follows:

1. **Use DHCP?** Check this box if your network has a DHCP server and you want to use dynamic addressing. Otherwise, you must enter static IP address entries in the four fields which follow.
2. **IP Address:** Enter the network address. Leading zeroes are not required.
3. **IP Mask:** This should usually be 255.255.255.0 unless your network can work across multiple subnets.
4. **Gateway Address:** This should usually be the same domain and subnet address numbers as the IP Address, but with the last octet being .1.
5. **DNS-nameserver:** A default value is shown for reference only. DNS is not normally required for basic static IP network configurations to work. Your IT administrator will specify a value to work with mixed static/dynamic network setups.

**Save:** When you have made all of the necessary entries, press **Save** to apply the changes internally before rebooting the unit.

## System Setup

The **System Setup** page provides access to product information, licensing information and entry, and AoIP card information. It actually consists of four screens, selected by the **Product**, **Licenses**, **Password Setup**, and **AoIP Card** tabs. Figure 4-28 shows the screen produced when the **Product** tab is clicked.

Figure 4-28: System Setup - Product

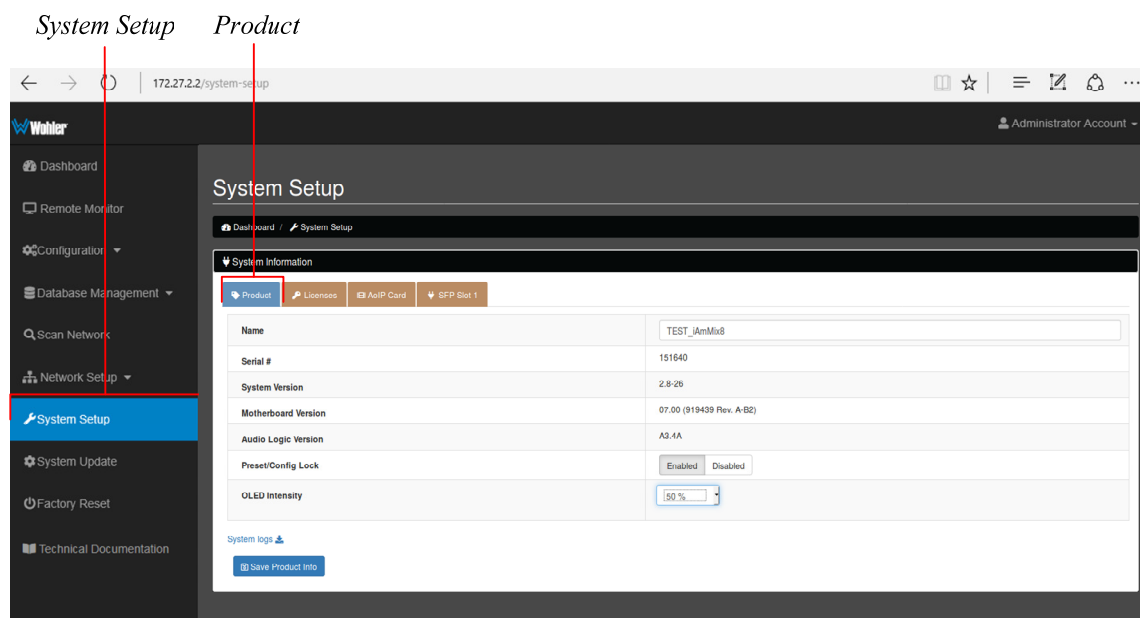

Most of the Product screen is informational. However, the **Preset/Config Lock** buttons allow you to Enable or Disable the front panel **Preset Config** button on the

product.

The OLED intensity control allows you to set the brightness of the front panel displays to suit the monitoring environment.

There is also a System Logs button on this screen. This button can be used to save System Logs into a file. The information in this file could be very useful, should you need to contact Wohler Technical Service for any reason.

Figure 4-29 shows the screen resulting from clicking the **Licenses** tab.

Figure 4-29: System Setup - Licenses

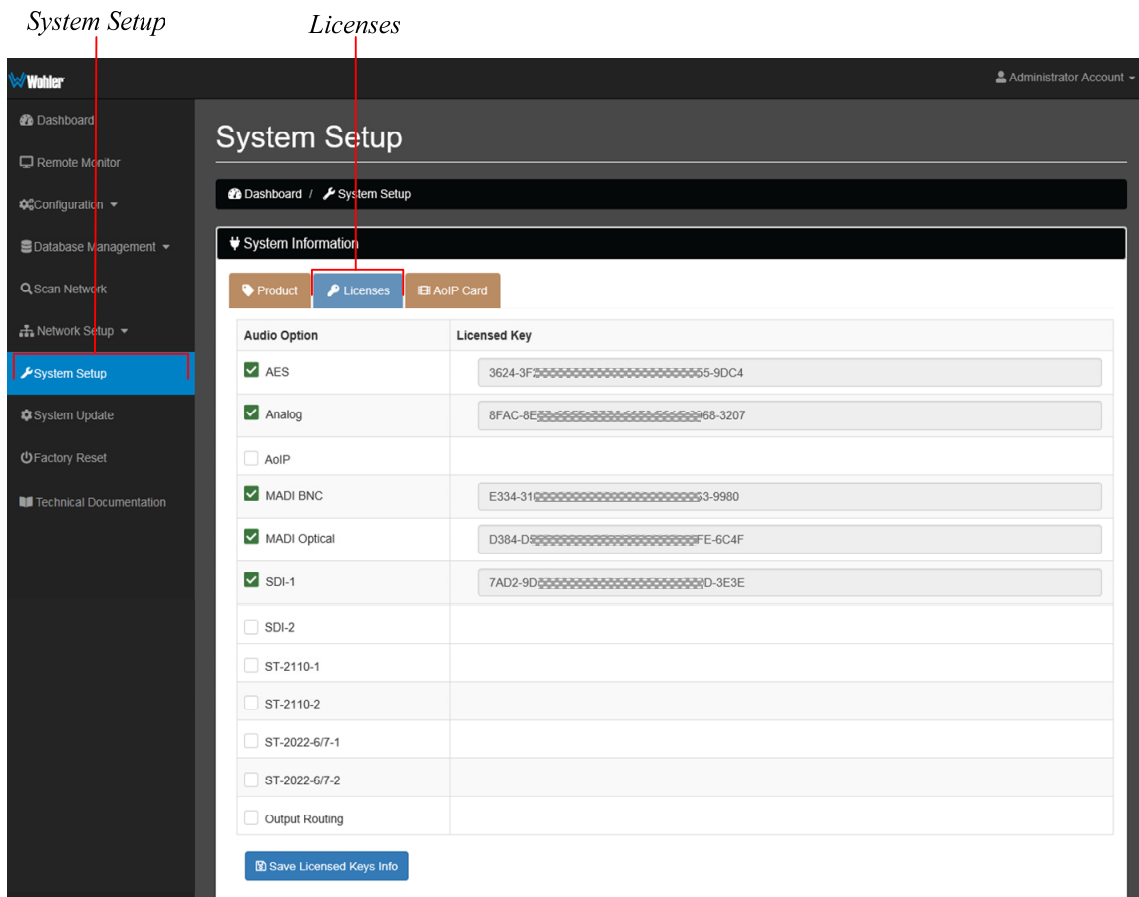

The Licenses screen displays the licensable options that the product is configured with, including their license numbers. The example above shows an iAM-MIX-8 with several sources installed and the license keys displayed for reference. Licenses without keys will not have the box checked. Click on an unchecked box to allow entry of the license key provided by Wohler Customer Service. Once entered, saved and accepted, the new license is available for use. Contact Wohler Sales to purchase licenses for needed options. A **Save Licensed Keys Info** button can be used to save the license numbers.

Figure 4-30 shows the screen resulting from clicking the **Password Setup** tab.

Figure 4–30: System Setup – Password Setup

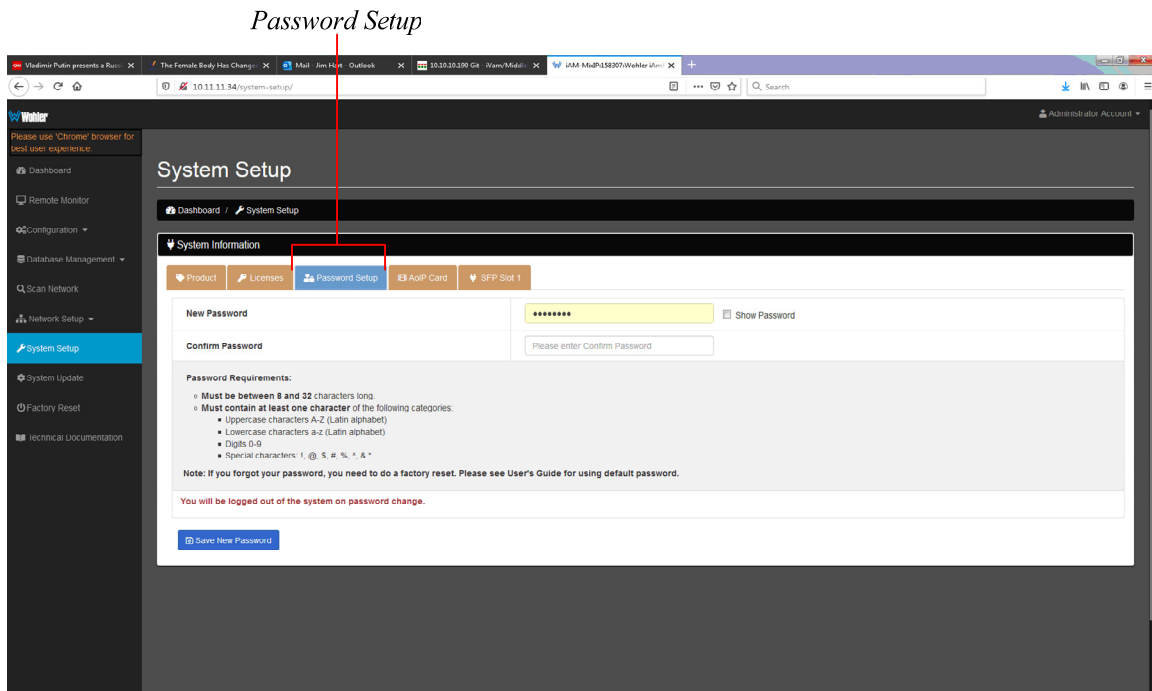

On this tab, you may easily devise a strong password for enhanced security. The password must meet the following requirements:

1. It must be between 8 and 32 characters long.
2. It must contain at least one character of the following categories:
  - a. Uppercase characters A-Z (Latin alphabet)
  - b. Lowercase characters a-z (Latin alphabet)
  - c. Digits 0-9
  - d. Special characters: !, @, \$, #, %, &, \*

Type the new password into the **New Password** field and then retype it into the **Confirm Password** field. Externally, make a note of the password you devised in a secure location for future reference.

**Note:** You will be logged out of the system when you change your password, and you will have to log in again using the new password.

**Note:** If you forget your password, you will have to perform a Factory Reset. Refer to the **Factory Reset** section of this chapter.



Figure 4-31 shows the screen resulting from clicking the **AoIP Card** tab.

Figure 4-31: System Setup - AoIP Card

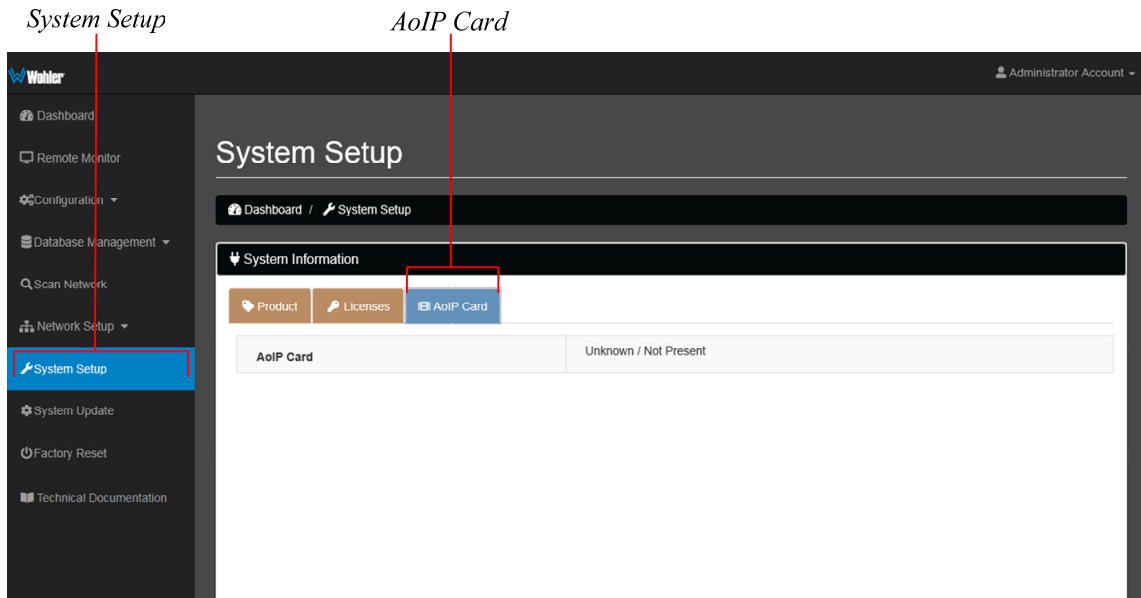

The example above shows an iAM-MIX-8 without an AoIP Card installed. Contact Wohler Sales to purchase this option if needed.

If an AoIP card is contained in SFP Slot 1 or 2, then the screen in Figure 4-32 can be selected.

Figure 4-32: System Setup - SFP Slot

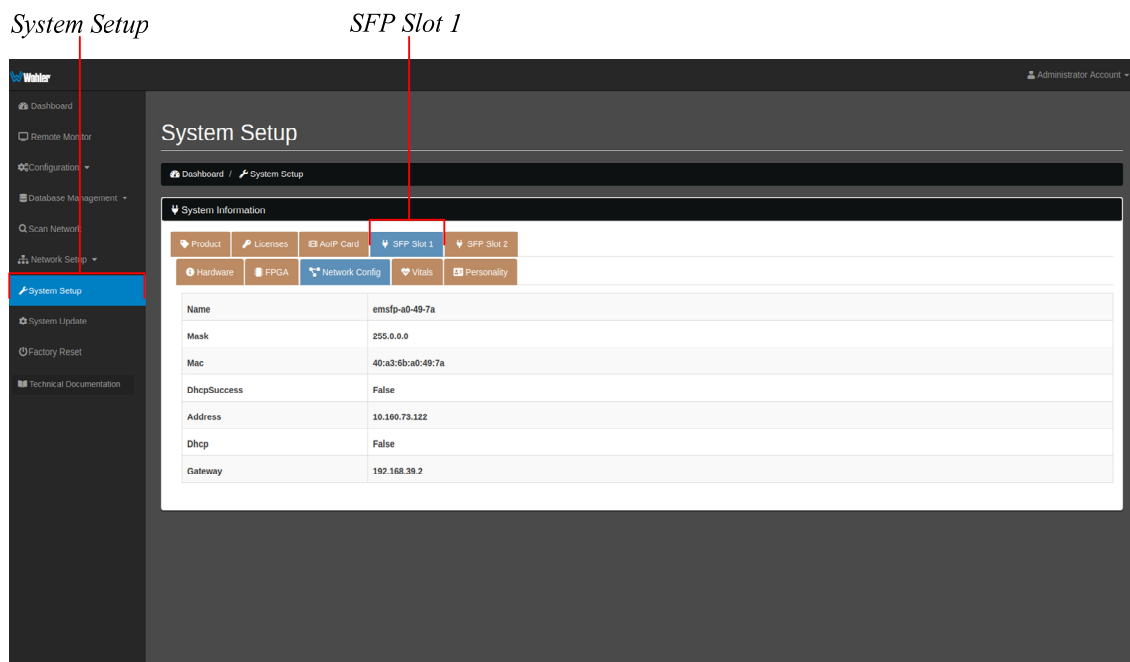

Information is displayed for the SFP cards that are inserted into the SFP Module

Cage Slots 1 and 2. This is particularly useful when setting up the SFP-2110 and SFP-2022-6 receiver card options, to check the network details.

## Factory Reset

It can be useful to bring all of the settings of the iAM-MIX back to the way they were when it left the Wohler factory if the iAM-MIX is being reinstalled at a new location. This page is used to reset all of the settings in the iAM-MIX to their original.

Figure 4–33: Factory Reset

*Factory Reset Selection*

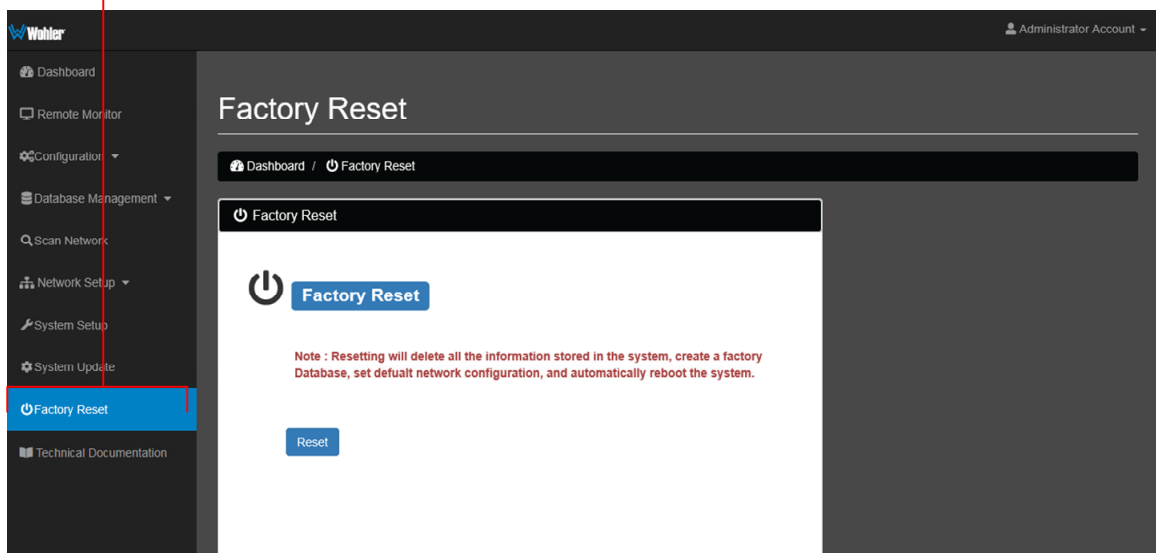

# Reboot System

The **Reboot System** page allows you to reboot an iAM-MIX remotely. The **Reboot System** page is shown in Figure 4-34. This function is normally only used upon request from Wohler Technical Service to troubleshoot or correct an issue.

The **Reboot System** function should be used with a bit of caution. It puts the iAM-MIX out of service for several minutes while it is rebooting, and this may unexpectedly interfere with the use of the product by the remote operator.

Figure 4-34: Reboot System

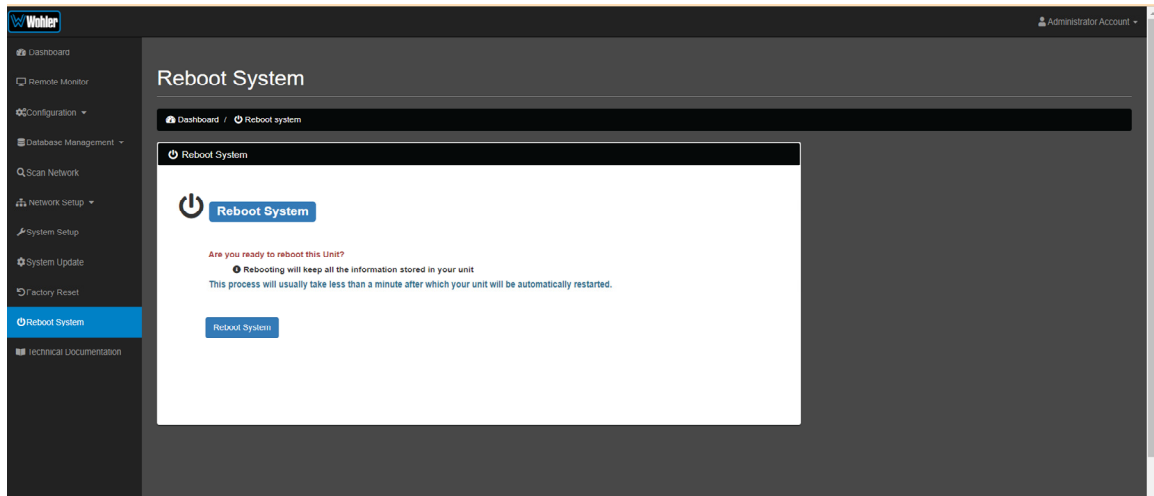

If you have any doubt as to whether you should reboot the remote iAM-MIX, do not click the **Reboot System** button. Contact Wohler Technical Service for advice.

# APPENDIX A: Software Upgrades

---

## Introduction

This chapter describes how to download a software update file to your computer, transfer it to a USB flash drive and install the update into an iAM-MIX.

## Download the Software

The iAM-MIX software update can be found at <http://www.wohler.com>, under Product Downloads on the Products > iAM-MIX page, in Support > Downloads > Drivers & Software, or contact Wohler Customer Support for more information.

Unzip and copy the update file(s) from your computer to the root directory (not inside a folder) of a USB flash drive. It must be FAT32 file type, and does not need to be empty.

Both local and network update methods require that a USB flash drive, with Wohler Update Package(s) installed on it, be inserted into the front panel USB jack.

### Important:

The iAM-MIX Web GUI is required to perform the software upgrade procedure. Refer to Chapter 4 **First Time IP Assignments** if not already set up for your network.

## Installing the Software Locally

Click on the **System Update** selection in the web browser GUI. The screen shown in Figure A-1 will appear.

**System Information** in the right pane shows currently installed software and hardware versions.

Figure A-1: System Update

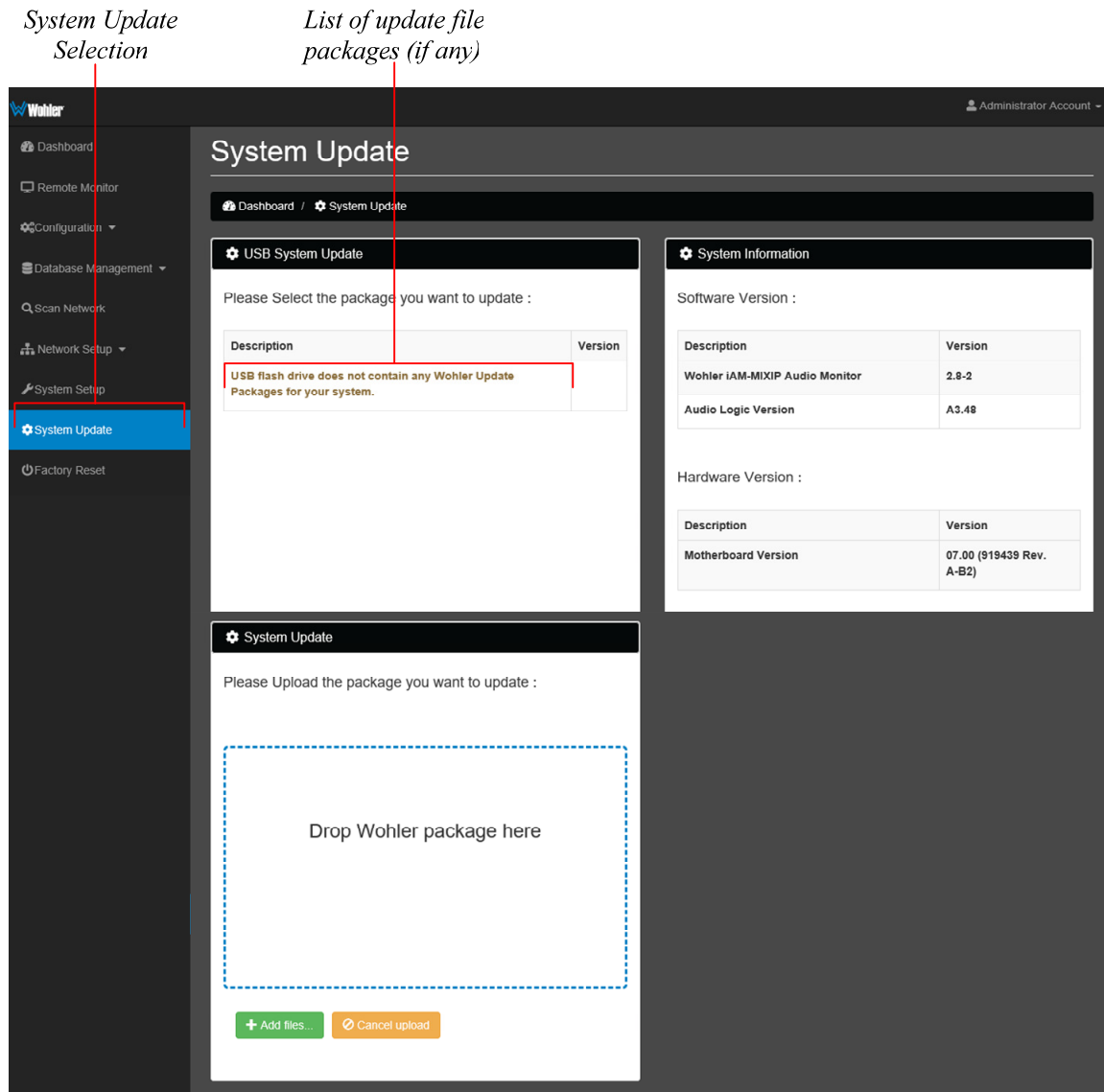

Use the following steps to install a new software package into the iAM-MIX:

1. Insert the USB flash drive with iAM-MIX update package(s) into the front panel USB jack. Refer to the [Download the Software](#) section of this chapter for the specifics of download and file transfer to the USB flash drive.
2. A list of update file packages present on the USB drive will appear in the **Description** field area shown in Figure A-1, along with software **Version** number(s). Click on the one you want to use. If the **“USB flash drive does not contain ...”** message below appears, the system has the latest software in it, and no further action is required or possible.
3. Click the **Start Upload** button.

### Important:

**Do not interrupt or remove power to the iAM-MIX, or remove the USB drive during the installation process.** Doing so could crash the iAM-MIX software.

4. The Web GUI will indicate progress of the software installation and results.
5. The iAM-MIX will display a message when the upgrade is complete and then reboot.
6. Remove the USB drive any time after upgrade is complete.
7. The iAM-MIX is finished upgrading and rebooting after the Power indicator returns to its green color and the front panel display is back to normal. The flash drive may now be removed from the iAM-MIX unit.
8. After the iAM-MIX reboots, either **Refresh** the browser by clicking on the Wohler logo, or close and reopen the browser for normal operation of the Web GUI.

## Updating an iAM-MIX Remotely

### Important:

The Web GUI is required to perform this software upgrade procedure. Refer to Chapter 4 **First Time IP Assignments** if not already set up for your network.

Remote upgrading is available for any networked iAM-MIX that is currently at version 2.8-2 or higher. This feature is useful if it is inconvenient to physically access some of the iAM-MIX units in the system to insert a flash drive. You may download an update file from the Wohler Web Site ([www.Wohler.com](http://www.Wohler.com)) and access the downloaded file directly from the Web GUI.

Use the following steps to remotely upgrade an iAM-MIX unit:

1. Download the update file into the computer containing the Web GUI. Refer to the [Download the Software](#) section of this chapter.
2. Connect to the iAM-MIX to be updated using the Web GUI.
3. Click on the **System Update** tab and locate the **System Update** box at the bottom of the screen. Refer to Figure A-2.
4. You click the **Add Files** button to locate and select the downloaded update file or, on Versions 3.4-19 or above, you may drag and drop the update file you downloaded into the "Drop Wohler Package Here" box.
5. Before proceeding, note that the iAM-MIX that is being upgraded will no longer be operational for the duration of the update. **If there may be other personnel who may using or need to use this iAM-MIX unit, notify them that the unit will be out of service for a time. During that time,**

- they must not power down or otherwise disturb the unit.**
6. Click the **Start Upload** button. The update will proceed automatically and the iAM-MIX will restart at the end of the update.
  7. Should you decide to stop the update, click the **Cancel Upload** button.
  8. After the iAM-MIX unit reboots, either **Refresh** the browser by clicking on the Wohler logo, or close and reopen the browser for normal operation of the Web GUI.

## Updating Multiple iAM-MIX Units

### Important:

The Web GUI is required to perform this software upgrade procedure. Refer to Chapter 4 **First Time IP Assignments** if not already set up for your network.

Remote upgrading is available for any networked iAM-MIX that is currently at version 2.8-2 or higher. This feature is useful if multiple units are to be upgraded and it is inconvenient to visit each one with a Flash Drive. The **Scan Network** page will scan the network for Wohler iAM monitors installed on the network and allow firmware updates of one or more compatible and accessible iAM-MIX units.

The following requirements apply:

1. All of the iAM-MIX units must be networked on the same IP subnet.
2. All networked iAM-MIX units that are to be updated remotely must already be at software version 3.2-0 or higher. These will be the **Target** units of the upgrade.
3. Each iAM-MIX unit must be of the same type. For example, an iAM-AUDIO cannot be updated by an iAM-MIX.

Use the following steps to remotely upgrade the **Target** units from the **Source** unit:

1. Download the update file into the computer containing the Web GUI. Refer to the [Download the Software](#) section of this chapter.
2. Click the **Scan Network** page selection. The network will be scanned and the iAM-MIX units found will be displayed on the **Discovery** tab. You may use the **Scan** button to rescan if you need to.

Figure A-2: Active Device Discovery

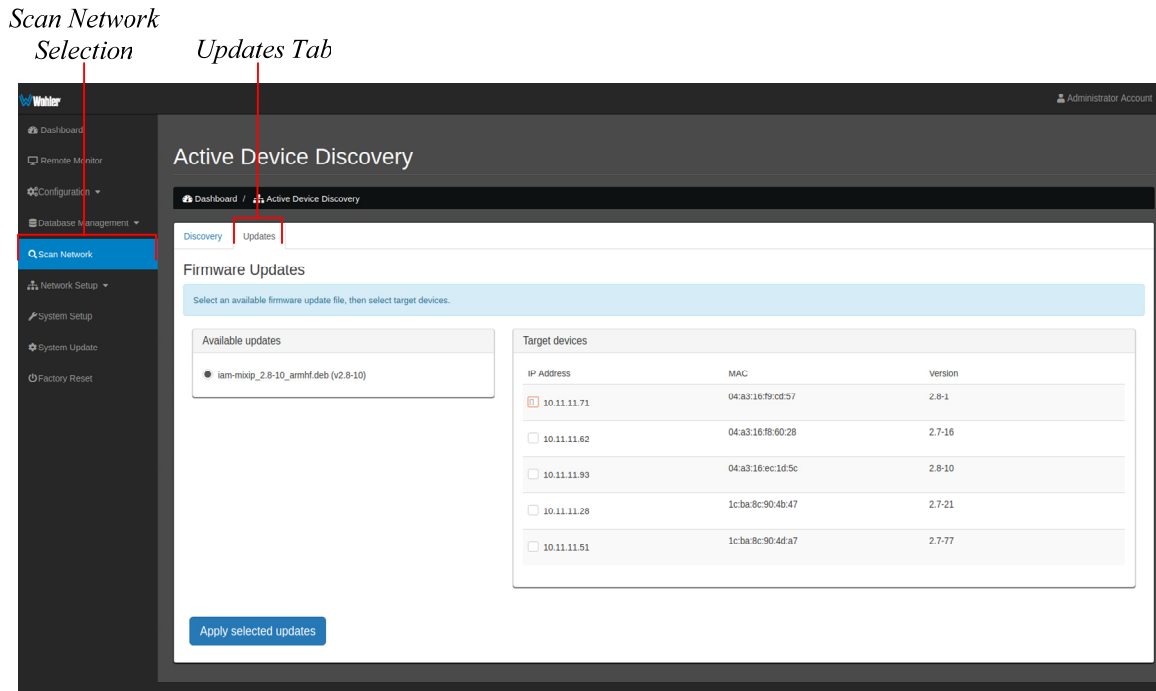

3. Click the **Updates** tab. Two boxes will show. The **Available Updates** window will show the available options for upgrade. If the update file you want is in the list, select it and proceed to Step 5 of this procedure. To add a new update file, click **Add File** and select the new update file. This file may be located on a flash drive inserted into the Web GUI PC, or it may be elsewhere within the file system of the Web GUI PC.
4. After the file has loaded, the network will be rescanned for **Target** units. Click the **Updates** tab. In the **Available Updates** section, select the needed the update file that you have just added.
5. The **Target Devices** window will show a list of the iAM-MIX **Target** units that are available to receive the upgrade. iAM-MIX units that have already been upgraded or are already at a higher version number will not appear on this list. Select the **Target** units that you would like to upgrade.
6. Before proceeding, note that each iAM-MIX **Target** that is being upgraded will be inoperative for the duration of the update. **If there may be other personnel who may using or need to use one of the remote iAM-MIX units, notify them that the unit will be out of service for a time. During that time, they must not power down or otherwise disturb the unit.**
7. Click the **Apply Selected Updates** button. A window will appear to show the progress of the software upgrade.



**Important:**

**Do not interrupt or remove power to any of the iAM-MIX units being updated, and do not remove the USB drive during the update process.** Doing so could crash the iAM-MIX software.

8. When the update is complete, each updated **Target** unit will restart and again be ready for use.
9. If you have also updated the unit to which the Web GUI is connected, after the iAM-MIX unit(s) reboot, either **Refresh** the browser by clicking on the Wohler logo, or close and reopen the browser for normal operation of the Web GUI.

# APPENDIX B: Dante Network Setup

---

## Introduction

Installing the iAM-MIX into an existing and functioning Dante network is virtually plug and play. The iAM-MIX rear panel AoIP jack supports 1Gb/s and 100Mb/s Ethernet devices in Dante Audio over IP network configurations.

iAM-MIX channel source selections are made by choosing **Input Type 'AoIP'** in the [Configuration-Configure Presets](#) page regardless of which AoIP option is installed.

The iAM-MIX is set up at the Wohler factory to be used as a slave rather than a master within the Dante network. Other devices or software, such as a **Dante Controller**, are expected to be responsible for most device configurations and all audio routing.

Please refer to the **Dante Controller User Guide** or other control device documentation for specific network and device setup information. The next section provides a guide to configuring the card and AOiP port.

## What is in the iAM-MIX for Dante

The Dante AOIP option consists of an Audinate Brooklyn II card directly connected to the AOIP port. This port is dedicated to the card and should not be confused with the Wohler unit Management port. These two ports must be on two different subnets, one for the AOIP network and the other for access to the Wohler Web GUI for management of the Wohler unit itself. Either one can be configured to have static or DHCP addresses. The Wohler Web GUI indicates the presence of the Dante card and the AOIP license but does not provide access to the various configuration parameters internal to the card. The speed of the AOIP port is 1G default or 100Mbps.

The Audinate® Brooklyn II card has a simple process to set its initial IP address. The initial factory setting for the card's AOIP port is DHCP. When connected to a DHCP based Dante network and the unit powered on, the Dante card sets the DHCP server provided address as its default address.

Therefore, if the Dante network has a DHCP server, the unit can be inserted into the network and can be configured further using the Audinate application, Dante Controller, running on a host on the same DHCP based subnet.

If the Dante network is static based or if DHCP fails, the card sets a static Link Local arbitrary address in the format 169.254.x.y, where x and y are each in the range 0 to 255. The mask is set to 255.255.0.0 to provide a ~65000 entry address space.

The Dante Controller host must also have a Link Local address to communicate with the card over the unit's AOIP port. Connect the AOIP port directly to a host (e.g. laptop) running the Dante Controller, where the host address is preconfigured to an arbitrary Link Local address (169.254.x.y, mask 255.255.0.0). The connection can be direct cable or through a switch. The Dante Controller **Device Info** tab shows

the card's default static address, speed, etc. By double clicking its entry line, additional settable parameters on the card can be reconfigured to be compatible with the Dante network addressing and other parameters as necessary. When the unit is rebooted on the Dante network, the card will be seen by the Dante Controller used to manage the overall network.

If the Dante Controller **Device Info** tab detects the card but does not allow modification and full presentation of card internals, the **Card ID** will be shown in red, e.g. Wohler-xxxxxx where xxxxxx is the last 6 hex digits of the card MAC address as shown in B-1. This usually indicates that the IP address of the card is not in the same subnet as the Dante Controller host. By double clicking the ID, a **Device View** screen will appear as also shown in Figure B-1 with further details about the two incompatible addresses. Change the address of the host or move the unit to another host with an address compatible with the Dante card.

Figure B-1 – Dante Controller Device Info Tab

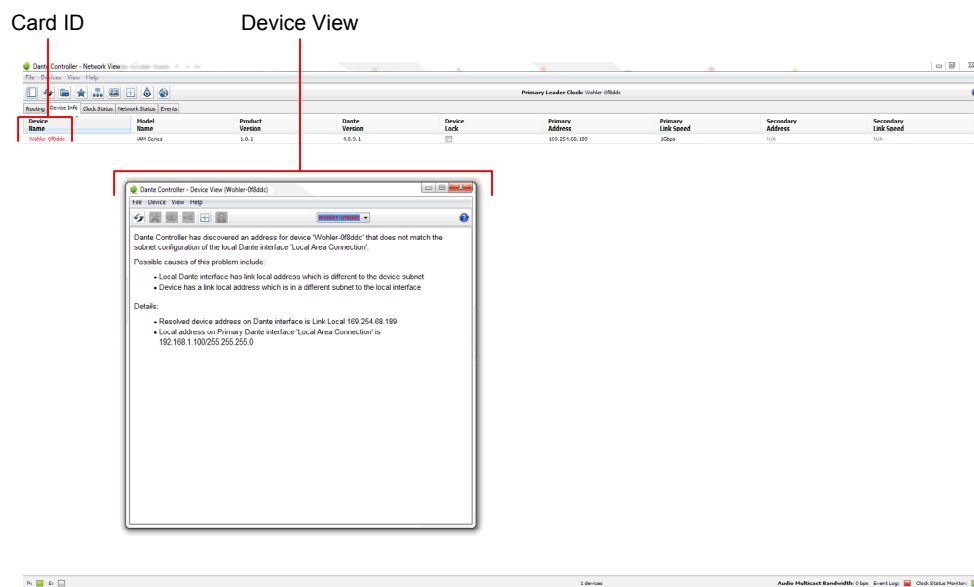

Up to sixteen of the 64 AoIP receive channels can be monitored at once in the iAM-MIX. The sixteen iAM-MIX input channels selected by Presets are transmitted to the Dante network.

**The iAM-MIX Dante AoIP is configured by the iAM-MIX to receive up to 64 channels and transmit 62 channels of Dante AoIP at 48 kHz or 44.1 kHz audio sample rates. 48 kHz is the iAM-MIX default rate.**

**Note:** Contact Wohler for the Dante configuration software that enables transmission of up to 62 transmit channels.

Sample rate selection is left up to the Dante Controller device or software. *All devices connected to each other through a Dante network must be set to the same sample rate.* Slight ticking may be heard in the iAM-MIX monitor when monitoring different input types at different sample rates or if the sources are asynchronous.

# Dante Device Setup

The iAM-MIX's default **Dante Device Name** is "Wohler- ..." followed by the last 6 digits of the Dante port MAC address, as shown in Figure B-2. This name can be changed by the Dante Controller to appear that way on the network, but that will not change the iAM-MIX unit name appearing on GUI pages and iAM-MIX remote metering or discovery pages.

Figure B-2: iAM-MIX Name

*Dante Device Name*

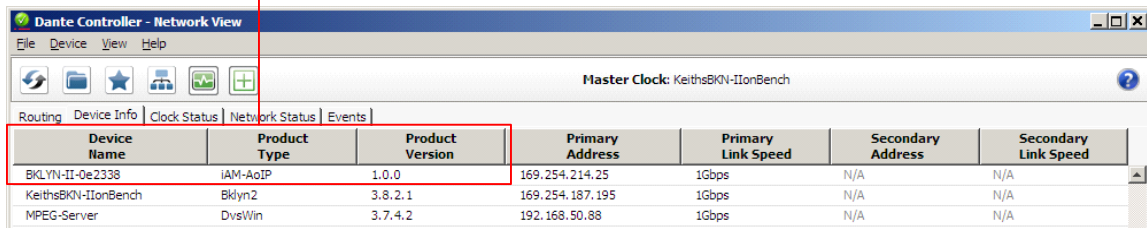

Device Name	Product Type	Product Version	Primary Address	Primary Link Speed	Secondary Address	Secondary Link Speed
BKLYN-II-0e2338	iAM-AoIP	1.0.0	169.254.214.25	1Gbps	N/A	N/A
KeithsBKN-IIonBench	Bklyn2	3.8.2.1	169.254.187.195	1Gbps	N/A	N/A
MPEG-Server	DvsWin	3.7.4.2	192.168.50.88	1Gbps	N/A	N/A

Initial setup operators may want to manually change the iAM-MIX unit Name in the [System Setup](#) page to match the reassigned Dante Device Name for consistency. Refer to Figure B-3.

Figure B-3: Rename iAM-MIX

*Change the iAM AoIP Name*

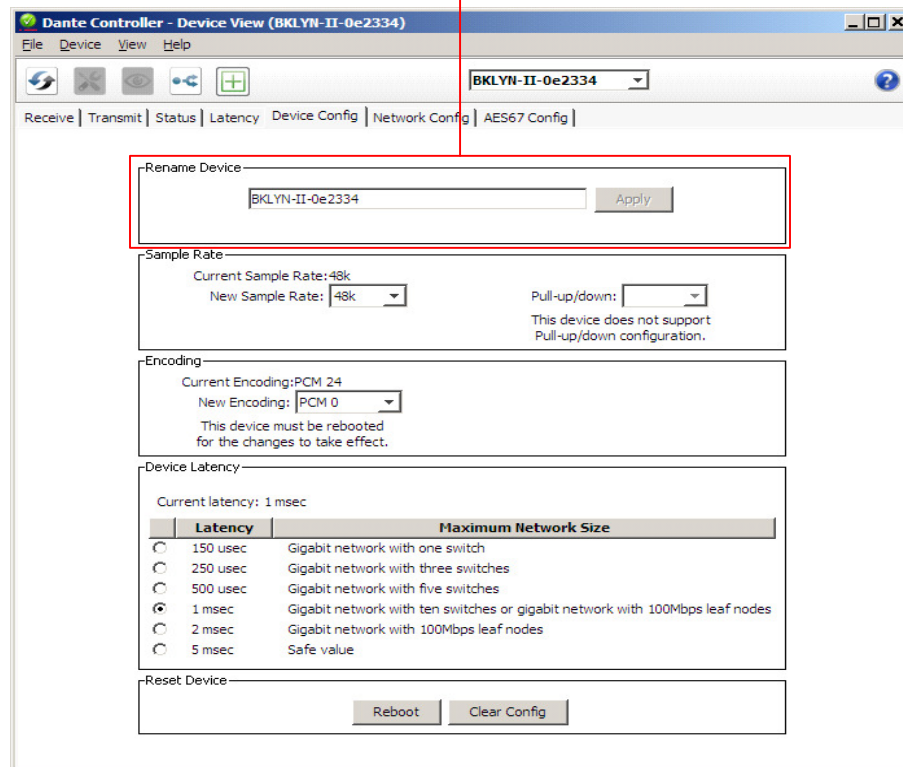

Rename Device

BKLYN-II-0e2334 [Apply]

Sample Rate

Current Sample Rate: 48k  
New Sample Rate: 48k [Pull-up/down: ]  
This device does not support Pull-up/down configuration.

Encoding

Current Encoding: PCM 24  
New Encoding: PCM 0  
This device must be rebooted for the changes to take effect.

Device Latency

Current latency: 1 msec

Latency	Maximum Network Size
<input type="radio"/> 150 usec	Gigabit network with one switch
<input type="radio"/> 250 usec	Gigabit network with three switches
<input type="radio"/> 500 usec	Gigabit network with five switches
<input checked="" type="radio"/> 1 msec	Gigabit network with ten switches or gigabit network with 100Mbps leaf nodes
<input type="radio"/> 2 msec	Gigabit network with 100Mbps leaf nodes
<input type="radio"/> 5 msec	Safe value

Reset Device

[Reboot] [Clear Config]

Other changes such as **Latency** settings can be made by the Dante Controller

through the **Device View** menus. Some changes may require remote rebooting of the Brooklyn II card to take effect, temporarily interrupting audio and publishing the new information to the network.

**Important:**

Only 44.1 kHz and 48 kHz audio sample rates are currently supported by the iAM-MIX. The Brooklyn II card would accept a Dante Controller command to operate at other rates, without giving an indication it will not be implemented.

## Dante Clock Selection

While the Brooklyn’s internal clock is highly accurate, the iAM-MIX does not have provisions for external sync clocks, such as those that are GPS or media reference (video genlock or audio word clock) based. So it is generally not the best candidate to be the PTP Master Clock (commonly called the “grandfather clock”) for the network. It can be set as the preferred master if no better clock source exists. Refer to Figure B-4.

The iAM-MIX Brooklyn Dante card will serve as a temporary fallback clock source if preferred masters are interrupted. It functions as an accurate slave clock synchronized to the master clock on the network when not operating as the master.

Figure B-4: Clock Selection

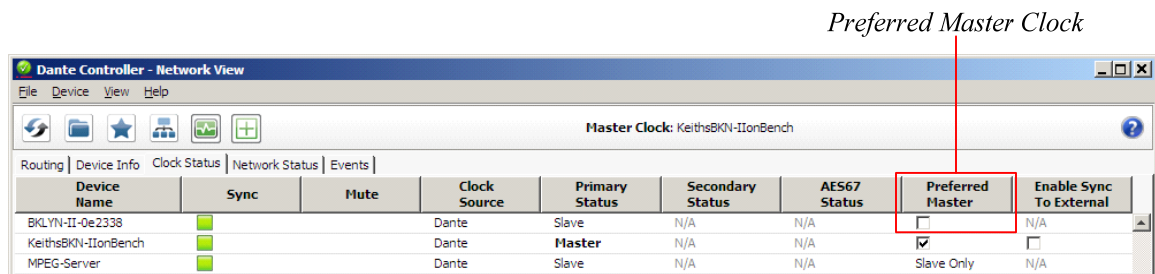

## Channel Names

The iAM-MIX uses the BKLYN-II default network channel names of Tx 01-16 and Rx 01-64. The network controller can change these names as desired, but iAM-MIX channel selections will remain as the original default numbers, unless changed in the [Channel Naming - AoIP](#) page. Note these iAM-MIX internal channel names are not passed to the Dante network for discovery purposes, and are internal to the iAM-MIX.

It is recommended for best operator understanding and system administrator reference that channel name changes made over the Dante network be manually entered in the iAM-MIX **Channel Naming - AoIP** page to match.

# AES67

The iAM-MIX Brooklyn II can be configured for AES67 operation. AES67 operation with Dante is limited to eight or less receive and transmit channels at 48 kHz sample rates.

24 bit linear (L24) encoding and 1 msec packet time are fixed default transmit parameters.

16 bit (L16) or 24 bit (L24) encoding and 125/250/333/100 µsec packet times can be received.

The **Device View - AES67 Config** menu enables/disables AES67.

Figure B-5: AES67 Enable/Disable

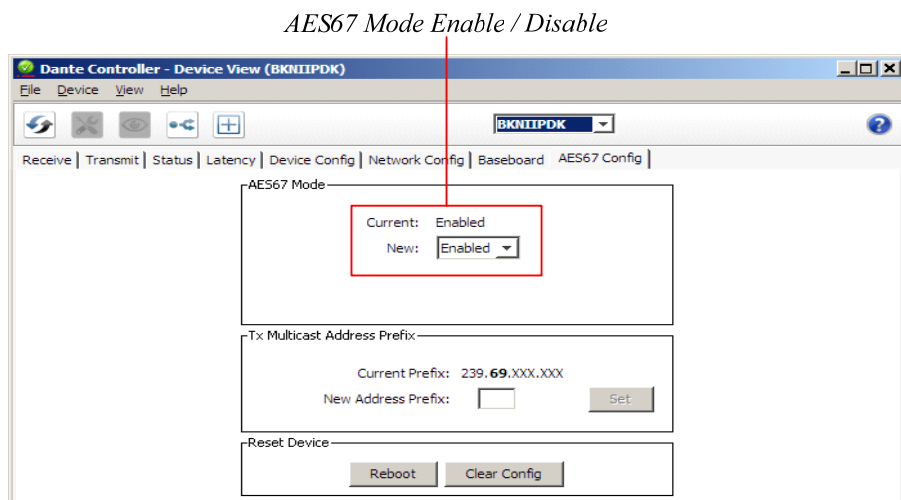

Further, Dante AES67 discovery and operational protocol requires manual assignments for static multicast transmit and receive IP addresses per Dante protocols for discovery and IGMP network operation. Destination addresses in range 239.nnn.0.0 – 239.nnn.255.255, port 5004 or nnn can be configured using the Dante Controller. The default is 69. The destination and receive address range must match. Provisions for this are in **Dante Controller Device View - Network Config**. Refer to Figure B-6.

Figure B-6: Device View - Network Config

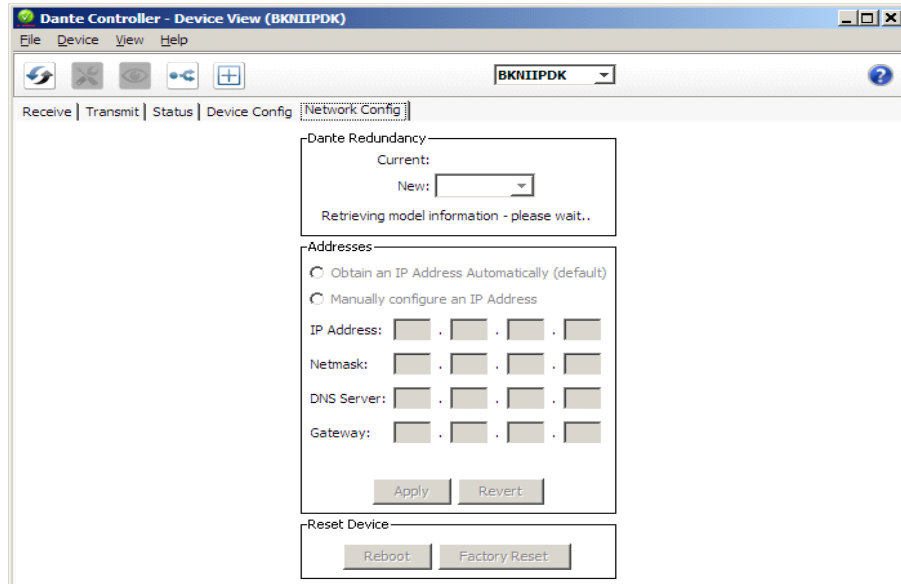

The channels to be multicast are selected in the File menu-**Create Multicast Flows** window shown in Figure B-7.

Figure B-7: Multicast

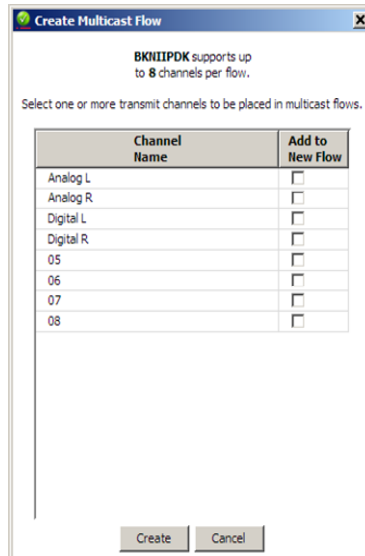

# Stream Destinations

Table B-1 illustrates the possible channel assignments in the iAM-MIX.

Table B-1: Channel Assignments

Channels	iAM-MIX Assignment
0-15	Front Panel Channels
16-31	SDI-1
32-39	ASRC
48-57	Mute
58-61	Output Routing Mix Channels
62-63	Mute

## Device Lock

Audinate recently added a feature whereby a remote controller can send a command to lock Dante network devices' configurations. The iAM-MIX does not implement the Device Lock command at this time.

## Dante Firmware Upgrades

Wohler iAM-MIX monitors ship with current Brooklyn II firmware as of the option installation date. The version information is found in the **Dante Controller Device View-Status** page. iAM-MIX software/firmware is tested with the latest Dante code release. Therefore it is strongly recommended that iAM-MIX and Dante software/firmware be updated at the same time to ensure compatibility and support of the latest features.

Use the Audinate **Dante Firmware Update Manager** Windows or OS X application to update the Dante firmware over the Dante network. Follow the application's installation and usage guide plus any applicable technical notes available.

## Additional Information

The following links are provided for those who need more information about the Dante controller or the Dante Firmware update manager.

<https://my.audinate.com/products/firmware-update-manager>

<https://www.audinate.com/products/software/dante-controller>

<https://dev.audinate.com/GA/dante-controller/userguide/pdf/latest>



## Dante™ Legal Disclosures

TRADEMARK ATTRIBUTION: Products covered in the manual include licence from Audinate Pty Ltd under US Patents 7747725, 8005939, 7978696, 8171152, European Patent 2255541, Chinese Patent ZL200780026677.0 and other patents pending or issued, see [www.audinate.com/patents](http://www.audinate.com/patents) or such other legend as Audinate may stipulate from time to time to the Manufactured Product and any packaging and marketing materials therefor.

# APPENDIX C: Ravenna (Coveloz) Setup

---

## Introduction

Installing the iAM-MIX into an existing and functioning Ravenna network using the Coveloz Bach board is virtually plug and play. The iAM rear panel AoIP jack supports 1Gb/s and 100Mb/s Ethernet devices in Ravenna Audio over IP network configurations.

iAM-MIX channel source selections are made by choosing **Input Type 'AoIP'** in the [Configuration-Configure Presets](#) page regardless of which AoIP option is installed.

**Note:** In addition to the iAM-MIX configuration, the Coveloz Bach board needs to be configured using its own configuration tool. The menus in this configuration tool are shown in this Appendix.

## What is in the iAM-MIX for Ravenna

The AES67 enabled Coveloz Bach board supports the following features:

### **RAVENNA-compatible talker/listener:**

- 1) RFC 3551 – RTP Profile for Audio and Video Conferences
  - a) L16 16-bit linear format defined in RFC 3551 clause 4.5.11
  - b) L24 24-bit linear format defined in RFC 3190 clause 4
  - c) AM824 24-bit Audio as defined in IEC61883-6
  - d) Multicast and unicast session support
  - e) 48 kHz and 96 kHz audio sampling rates
  - f) 1 to 8 audio channels per stream
  - g) Up to 256 streams
- 2) Media clock support
  - a) 48 kHz and 96 kHz
- 3) Hitless Stream Redundancy
- 4) IGMP v3 support
- 5) Session Announcement Protocol (SAP) support

### **AVB Ethernet features:**

AVB uses the concept of streams and channels. A stream is a connection from one talker to one or more listeners. One stream can be made up of 1-60 audio channels. The Ravenna option supports the following AVB features:

- 1) AVB 1722 AVTP with multiple subtypes:
  - a) IEC 61883-6 MBLA
  - b) AM824, 24-bit Audio Encapsulation
  - c) Support up to 64 streams
  - d) Up to 8 channels per stream
  - e) 512+512 Channels of audio
  - f) 48kHz and 96kHz sampling rates
- 2) IEEE 802.1Q/SRP

- 3) IEEE 1722.1/AVDECC control
- 4) IEEE 802.1AS/gPTP
- 5) Compatible with Apple OS X devices, such as MacBooks and MacMini computers
- 6) Media clock per the AVnu specification
- 7) Hitless stream redundancy

### **BACH™ Controller Graphical User Interface:**

The BACH board includes a Graphical User Interface to review and manage the Bach board. It provides an interface to:

- 1) Manage connections with ease
  - a) Display discovered devices and streams
  - b) Connect streams from network to local destinations
  - c) Start, stop and monitor stream health/status
- 2) Enable local BACH™ device configuration & status reporting. Examples include:
  - a) Receive buffer statistics
  - b) Ethernet statistics
  - c) Alarms

The context is device-specific, meaning that:

- 1) a stream "source" refers to this device's source
- 2) One can change context to another device by selecting it on the Cloud Page

# Home Page

You can navigate to different pages within the Bach Controller GUI to review or perform various functions.

The **Home** page can be accessed by entering the 172.27.2.30 IP address. It gives a device overview and stream status.

Figure C-1: BACH Controller Home Page

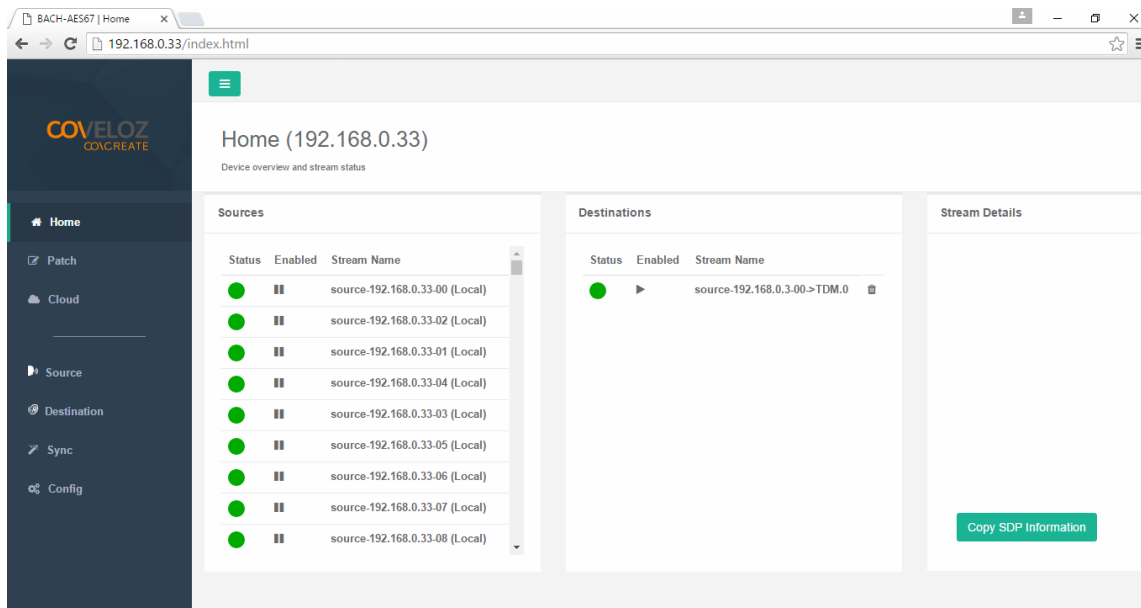

# Configuration/Device Management

The **Configuration** page allows operations such as modifying the IP address, Packet time, Rebooting and so forth.

The first step in setting up the Ravenna option is to configure the Ethernet IP address and other settings. The **Device Configuration** page allows operations such as modifying the IP address, Packet time, Rebooting etc.

**Note:** There are important considerations when setting up a Ravenna network. Ideally, the Ravenna network must be completely isolated from other Ethernet devices, such as computers, printers, and connections to the internet. This is because the timing of the communications on the Ravenna network is very critical. It should have its own 1Gbps router. However, at least one computer must be connected to the Ravenna network to perform configuration.

Set the Ethernet IP address of the Ravenna option into the "eth1" line on the **Device Configuration** page. The address must be on the same subnet as the other devices on the Ravenna network.

**Note:** The "eth0" setting is not to be used. Leave it at its default setting.

Next, check that the Sampling Frequency is 48 kHz and the Packet Time is 1ms or 250us. Check that the Firmware Version is the same as what is shown in Figure B-

3.

**Note:** ALL Devices must use the same packet time, or sources or destinations may not be available.

If you change any setting on the **Device Configuration** page, click **Save Running to Startup**. If you have changed any Ethernet IP addresses, click **Reboot Device**.

**Note:** The Ravenna card requires knowledge of its IP address in order for you to use its Web Client for further configuration.

**Note:** If you change the default IP address (172.27.2.30) to another Static address, make sure you document this change by writing down the new IP address and affixing it to the rear panel for your future reference. If you forget the new IP address, it can be very difficult to find it again.

**Important:** Setting the card into DHCP mode should be done only if the user has a convenient way to discover the newly assigned dynamic address. At minimum, we suggest setting the card to a Static address for initial testing. Ideally, all cards on the network should be visible to a Ravenna/AES67 network manager where dynamic IP addresses are readily knowable. The Web Client Cloud menu section may suffice as the network manager.

If you lose track of the IP address of a card, the only way to find it is to connect it to a very small network consisting of a computer, a switch and the card. Then use Wireshark or equivalent to discover its IP address.

Figure C-2: BACH Controller Device Configuration

Name	Ip	MAC	Link	Mode
eth0	192.168.11.1	70-B3-D5-04-20-80	●	static
eth1	192.168.0.33	70-B3-D5-04-20-61	●	static

# Controller Cloud

The **Cloud** page shows any Ravenna devices on the given network, including any Wohler devices with the Ravenna option installed.

Figure C-3: BACH Controller Cloud Page

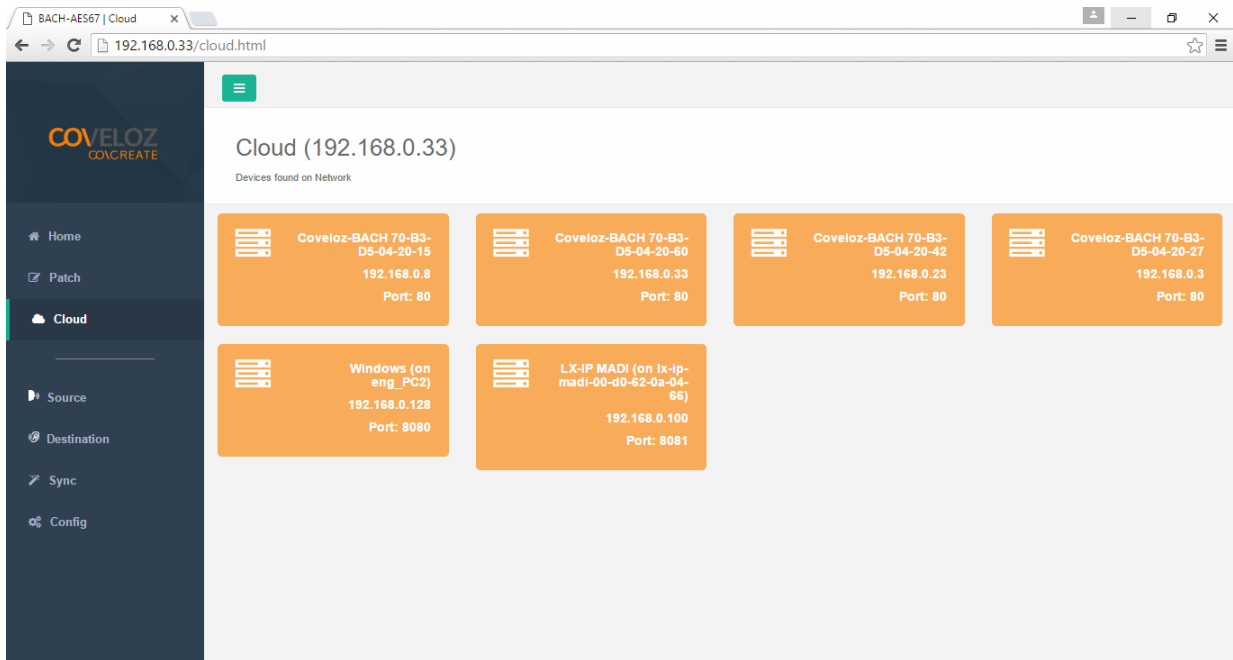

# Sync

The **Sync** page allows you to program parameters relating to Precision Time Protocol (PTP) based time synchronization of network clocks of your BACH-AES67 devices.

Figure C-4: BACH Controller Sync Page

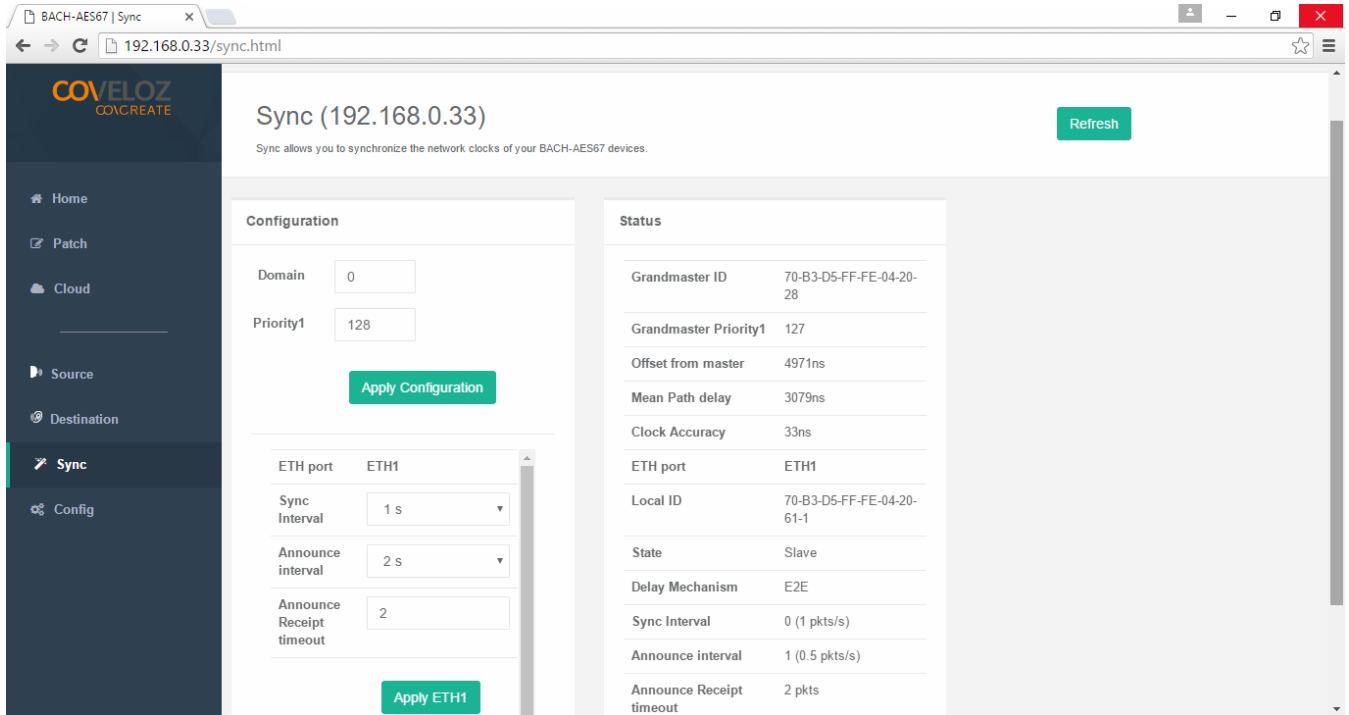

# Source Streams

The **Source** provides in-depth information on source streams that are transmitting (sourcing) Ravenna signals from devices on the network.

Figure C-5: BACH Controller Source Stream

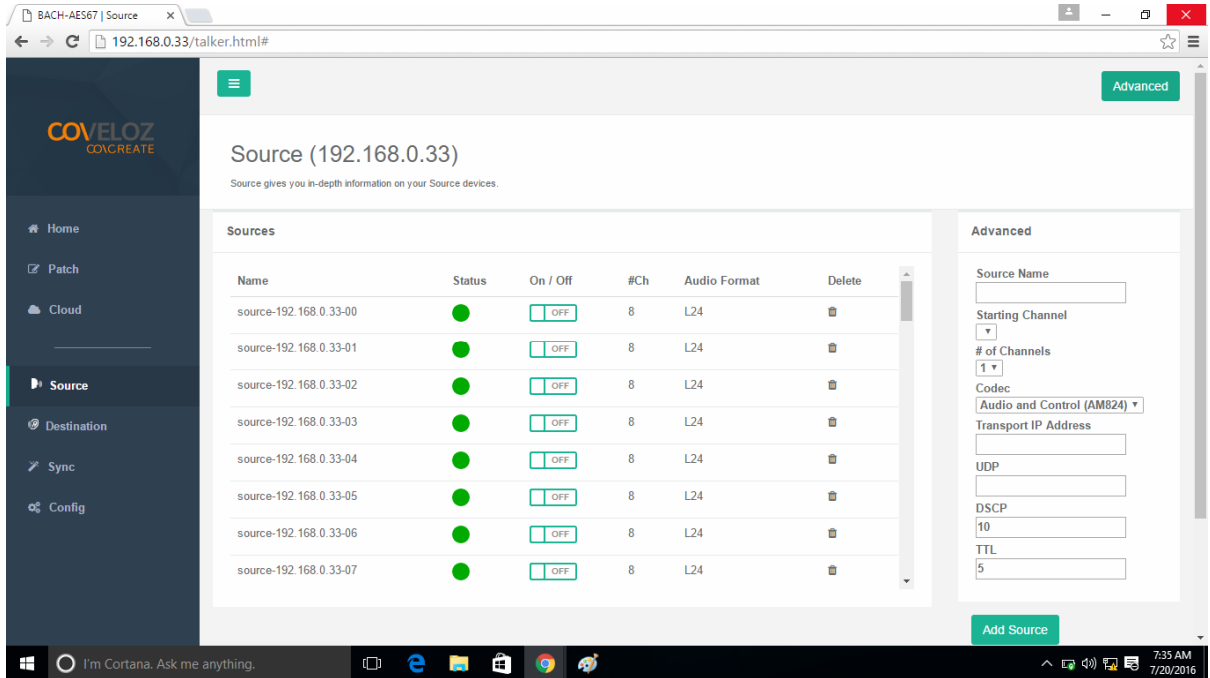



# Stream Destinations

The **Destination** page provides in-depth information on your destination devices that are receiving Ravenna signals on the network. Clicking the Advanced button provides additional options.

**Note:** The Destinations must be set to ON.

Table C-1 illustrates the possible channel assignments in the iAM-MIX.

Table C-1: Channel Assignments

Group/TDM	Channels	iAM-MIX Assignment
Group 0 (I2s)	Reserved	Reserved (do not use this group as a source)
Groups 1-2	0-15	Front panel channels
Groups 3-4	16-31	SDI 1
Group 5	32-39	ASRC
Group 6	40-47	Analog Inputs
Groups 7-8	48-57	Dolby Decoded Outputs
Group 8 Cont'd	58-61	Output Routing Mix Channels
Group 8 Cont'd	62-63	Mute
Groups 9-16	64-128	MADI
Groups 17-24	129-255	?

Figure C-6: BACH Controller Stream Destinations

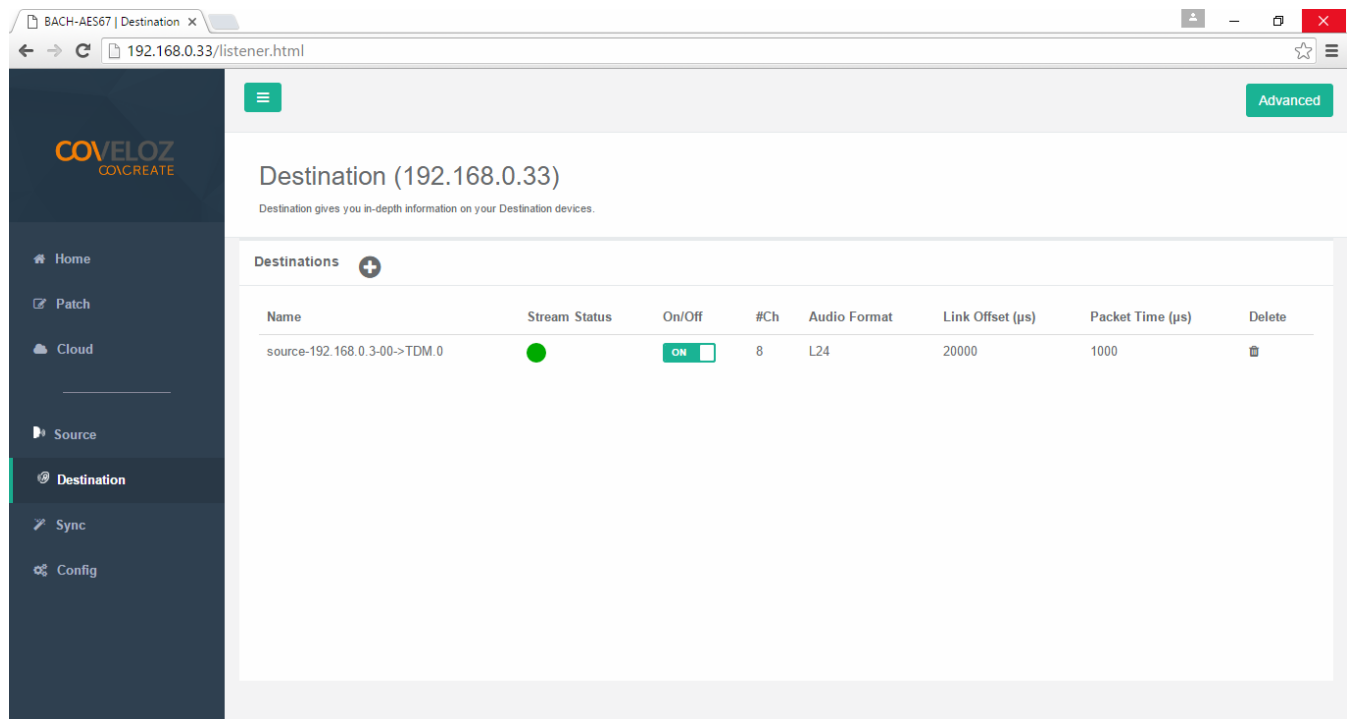

# Patch Panel

The **Patch** page enables routing of connections between listener and talker channels for devices on the network. The highlighted green square indicates a routing connection between a source or talker (left) and a destination or listener (bottom). The Web GUI will allow selection of channels to monitor from among the listeners (bottom).

Figure C-7: BACH Controller Patch Panel

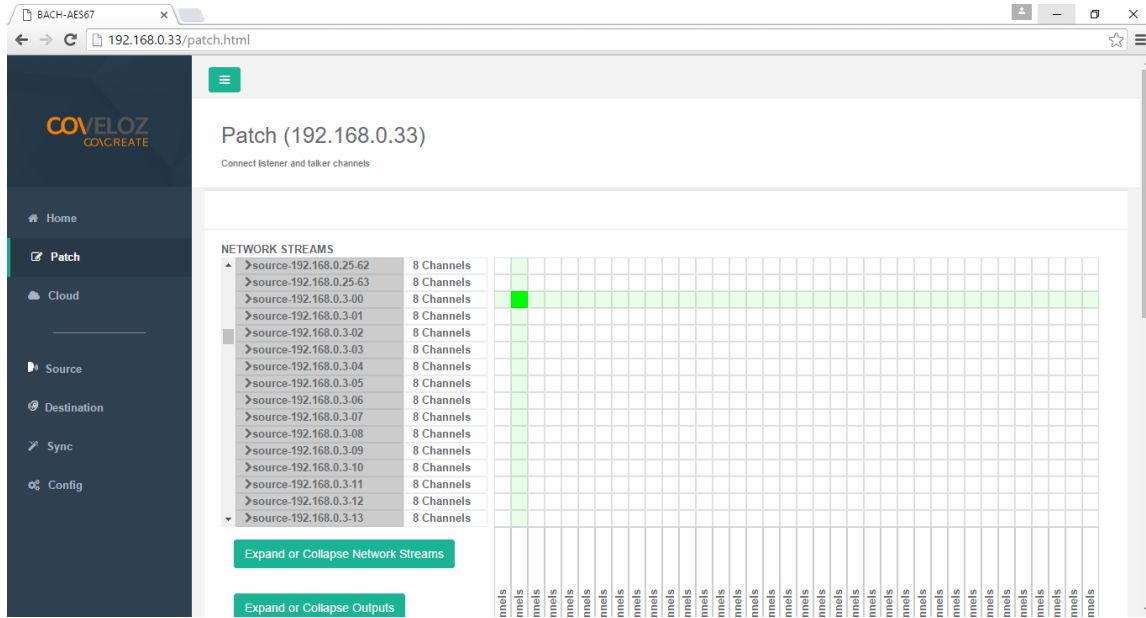

## Troubleshooting

It can happen that the iAM-MIX Ravenna option doesn't immediately operate as expected. This can be the result of a variety of causes. Refer to Table C-2 for solutions to the problem. If after following the advice in the table, you still cannot resolve the issue please contact Wohler Technical Services for additional help. Contact information is on the second page of this manual.

Table C-2: Troubleshooting

Symptom	Possible Solutions
Source or destination doesn't show up on the network	1. Restart the iAM-MIX.
	2. Restart the unit that doesn't show up.
	3. Restart the network.
Cannot open a web page for either a source or a destination	1. Go to the <b>Cloud</b> page of a working device and see if the source or destination is listed there. This will help determine whether the IP address was changed or simply entered incorrectly.

	2. Use software such as Wireshark* to check network traffic.
	3. Empty the cache of the browser.
Cannot route to a destination	1. Go to the Destinations tab, delete all of the destinations and then try to route again.
	2. Make sure that the source is turned on.
	3. Go to the <b>Dashboard</b> page and check the Sources and Destination blocks. Verify that they are ready and working without timing errors.

\* Wireshark is a free and open sourced packet analyzer software program. It can be used to analyze network traffic and locate IP addresses being used. It may be downloaded from [www.wireshark.org](http://www.wireshark.org).

## Ravenna Firmware Upgrades

Wohler iAM-MIX monitors ship with current Bach firmware as of the option installation date. The version information is found in the **Firmware** section of the **Bach Device Configuration** page. iAM-MIX software/firmware is tested with the latest Bach code release. Therefore it is strongly recommended that iAM-MIX and Bach software/ firmware be updated at the same time to ensure compatibility and support of the latest features.

If a Ravenna software update is indicated, follow instructions in the Coveloz Ravenna software update materials.

# APPENDIX D: Ravenna (ZMAN) Setup

---

## Introduction

Installing the iAM-MIX into an existing and functioning Ravenna network using the Merging ZMAN Card is virtually plug and play. The iAM rear panel AoIP jack supports 1Gb/s and 100Mb/s Ethernet devices in Ravenna Audio over IP network configurations.

iAM-MIX channel source selections are made by choosing **Input Type 'AoIP'** in the [Configuration-Configure Presets](#) page regardless of which AoIP option is installed.

**Note:** In addition to the iAM-MIX configuration, the Merging ZMAN Card needs to be configured using its own configuration tool. The menus in this configuration tool are shown in this Appendix.

## What is in the iAM-MIX for Ravenna

The AES67 enabled Merging ZMAN Card supports the following features:

### RAVENNA-Compatible Talker/Listener

- 1) RFC 3551 – RTP Profile for Audio and Video Conferences
  - a) L16 16-bit linear format defined in RFC 3551 clause 4.5.11
  - b) L24 24-bit linear format defined in RFC 3190 clause 4
  - c) AM824 24-bit Audio as defined in IEC61883-6
  - d) Multicast and unicast session support
  - e) 48 kHz and 96 kHz audio sampling rates
  - f) 1 to 8 audio channels per stream
  - g) Up to 64 streams
- 2) Media clock support
  - a) 48 kHz and 96 kHz
- 3) Hitless Stream Redundancy
- 4) IGMP v3 support
- 5) Session Announcement Protocol (SAP) support

### AVB Ethernet Features

AVB uses the concept of streams and channels. A stream is a connection from one talker to one or more listeners. One stream can be made up of 1-60 audio channels. The Ravenna option supports the following AVB features:

- 1) AVB 1722 AVTP with multiple subtypes:
  - a) IEC 61883-6 MBLA
  - b) AM824, 24-bit Audio Encapsulation
  - c) Support up to 64 streams
  - d) Up to 8 channels per stream

- e) 512+512 Channels of audio
- f) 48kHz and 96kHz sampling rates
- 2) IEEE 802.1Q/SRP
- 3) IEEE 1722.1/AVDECC control
- 4) IEEE 802.1AS/gPTP
- 5) Compatible with Apple OS X devices, such as MacBooks and MacMini computers
- 6) Media clock per the AVnu specification
- 7) Hitless stream redundancy

## Configuring the AOIP Merging Option Card

This appendix provides basic information about configuring the Merging ZMAN card by invoking the card's internal configuration application. The Merging card can be configured through a connection to the Ethernet AOIP Port using a browser on the Ravenna network and by using the Merging Aneman Windows application. Aneman is available for free download at:

<https://www.merging.com/support/downloads#aneman>

The iAM-MIX can be configured using its Front Panel controls or its web interface through its Management port. Details specific to the iAM-MIX can be found in Chapters 2 and 4 of this manual.

For a Quick Start, set the Source Select menu item on the Front Panel to AOIP to configure iAM-MIX to receive/source a Ravenna Stream over its AOIP port. The Source Select Menu control also allows selection of a range of channels in groups of 16 channels 1-16 ... 49-64. More details including definition of Presets and individual channel parameters are available by reference to other chapters of this manual.

The Merging Ravenna card runs specific firmware from Merging and augmented by Wohler for use within the iAM-MIX. The card will not function correctly if the user downloads and installs firmware from any source besides Wohler. The Wohler augmentation includes the ability to support 64 channels.

The Merging card is pre-configured to DHCP mode to obtain its IP address automatically from the Ravenna network. The Ravenna network should be a separate address space from the iAM-MIX Management port. For example, the iAM-MIX might be connected to a 10.11.11 subnet and the Ravenna network devices connected together on a 10.15.15 subnet. Aneman and a suitable browser must be resident on a host workstation on the same Ravenna subnet to access the Merging card. For this Appendix, the Ravenna network address will be referred to as <Ravenna subnet>. The Merging card address will then be <Ravenna subnet>.x where x is the specific address of the card on the subnet.

Power the iAM-MIX and verify the Ethernet connector LEDs are lit and/or blinking. It may take a few minutes for the card to be fully recognized on the Ravenna network after powering the iAM-MIX.

For Aneman access, the card parameters including its IP address should appear in a panel at the bottom of the screen. In Aneman, make sure Devices under Menu

item View is enabled. Do not proceed until the card shows on Aneman. Right click on that line and select Web Services: Advanced (or Ravenna) to bring up the Merging Ravenna configuration page. Also, the ICON of the card will appear in the main part of the Aneman screen. Double Clicking on the ICON also will load the Configuration screen.

For browser access, the URL is <Ravenna subnet>.x/advanced/index.html. This brings up the Merging Ravenna configuration page. Each tab is explained in the following sections.

## Getting Started | General Settings

This tab is shown in the following figure.

Figure D-1: Getting Started | General Settings

The elements of this tab are as follows:

1. **Device Name:** Enter a useful Device Name for the card, which will show up on other Ravenna devices on the subnet.
2. **Sample Rate:** (44100-48000- 88200-96000-176400-192000-352800-384000)
3. **Frame size (@1Fs):** current frame size (64 - AES67/48 - 32 -16 - 12 -6).
4. **Safety Playout Delay (@1Fs):** The value is described at 1Fs (44.1-48 kHz) in samples. For example, if the value is 10, the additional playout delay will be 20 at 2Fs (88.2-96 kHz), 40 at 4Fs (176.4-192 kHz)
5. **SSM Source-Specific Multicast:** If needed, configure the network switch for IGMP V3.
6. **Network Interface:** Note the address of the card and its type (Zeroconf, DHCP, Static). (If necessary, the address can be changed to another type such as a Static address which must include a Network Mask and Gateway.)

## Getting Started | PTP

This tab is shown in the following figure. This configuration page refers to how your Ravenna network is synchronized to clocks.

Figure D-2: Getting Started | PTP

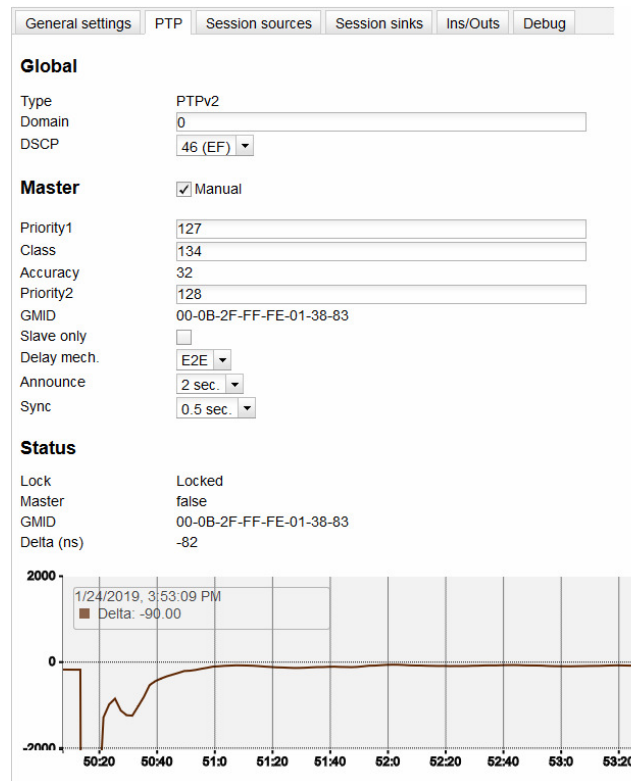

The elements of this tab are as follows:

- Global Settings:** The default value for PTP
  - Domain:** For the Merging Ravenna card this value is 0.
  - DSCP:** 46 for PTP AES67 or 48 for PTP Ravenna.
- Master:** To modify the PTP setting, you must first check the "Manual" checkbox.
  - Priority:** 1 is the main priority value.
  - Class:** This is the Device class. This value should not be modified.
  - Accuracy:** This field cannot be modified.
  - Priority 2:** This is only used if the other parameters do not allow electing a PTP master.
  - GMID:** This is the current GrandMasterID (PTP Master)
  - Slave only:** This forces the Merging device to always be PTP slave.
  - Delay Mech.:** This is PTP Profile related - E2E or P2P
  - Announce:** This is PTP Profile related - PTP announcement interval (1 - 2 - 4 - 8 -16 seconds)
  - Sync:** This is PTP Profile related (0.0625 - 0.125 - 0.25 - 0.5 seconds)

### 3. Status:

- a. **Lock:** This shows if the device is locked to PTP (Locked -Locking - Unlocked)
- b. **Master:** This is true or false for the current device.
- c. **GMID:** This is the current GrandMasterID (PTP Master)
- d. **Delta (ns):** This is the time delta between the device and the PTP master.

4. **Graph:** The graph is only active for slave devices and shows the device delta against Master PTP clock.

### 5. PTP Priority Value:

- a. 1 is the highest priority, 255 the lowest one.
- b. Merging card is by default using Priority 127 when set as PTP Master and 255 when PTP slave.

## Getting Started | Session Sources

This tab defines which Streams are to be Sourced from this card. It is shown in the following figure.

Figure D-3: Getting Started | Session Sources

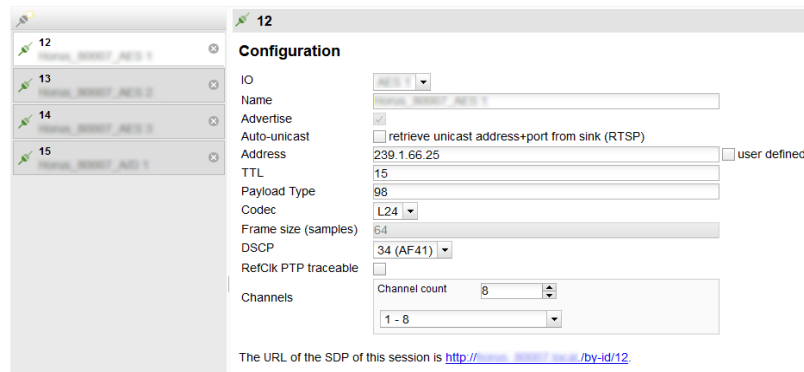

The elements of this tab are as follows:

1. **Create session button:** Create a new session sources by clicking on left ICON.
2. **IO:** Select the physical input (when applicable).
3. **Name:** This is the Source name.
4. **Advertise:** Check to enable source advertising on the network.
5. **Auto-unicast - (RTSP):** Check to automatically retrieve the sink (listener) IP address:port for unicast connection.
6. **Address:** This the stream's multicast address. Note that the user defined checkbox is activated automatically when entering a multicast address manually.



7. **TTL:** Time to Live (also called Hop Limit) - This value should not be modified.
8. **Payload type:** RTP Payload type - This value should not be modified.
9. **Codec:** The possible bit rate values are L24, L16, DSD64, DSD64\_32, DSD128, DSD128\_32, and DSD256. Note that these values are sampling rate dependent.
10. **Frame size (samples):** This the frame size of the current source.
11. **DSCP:** The audio DSCP should be set to 34 for RTP AES67 or 46 for RTP Ravenna.
12. **RefClk PTP traceable:** This feature is useful when you want to connect a stream through Internet (for example with two PTP Masters (GPS) at each location). This allows making connections with devices locked to different traceable PTP Masters. Refer also to Ignore RefClk GMID - accept source locked to any PTP master, on the Session Sinks tab.
13. **Channels:** This is the number of channels in the stream. The drop-down menu allows selection of specific channel range if the number of channels is less than 8.
14. **The URL of the SDP of this session:** This allows saving of the Session Description into a file, which is useful for specific third party devices if a manual SDP has to be provided.

## Getting Started | Session Sinks

This tab defines streams which are sinked in this card. It is shown in the following figure.

Figure D-4: Getting Started | Session Sinks

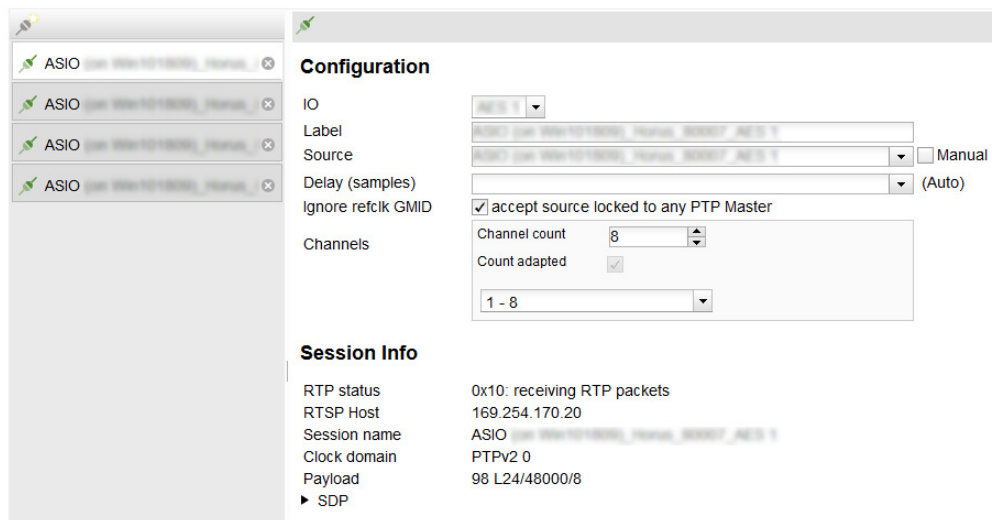

The elements of this tab are as follows:

1. **Create session button:** Create new session sinks by clicking on left ICON.
2. **IO:** Select the physical output (when applicable).
3. **Label:** This is the Sink name.

4. **Source:** This is a drop down menu to select a source (both sap and bonjour advertised sources are automatically listed).
5. **Manual:** This allows manual entry of an SDP.
6. **Delay (samples):** This sets the playback delay. 0 is automatic delay.
7. **Ignore RefClk GMID - accept source locked to any PTP master:** This feature is useful when you want to connect a stream through Internet (for example with two PTP Masters (GPS) at each location. This allows making of connections with devices locked to different traceable PTP Masters. See RefClk PTP traceable on the Session Sources tab.
8. **Channels:** Channel count: The drop-down menu allows selection of specific channel range if the number of channels is smaller than 8.

## Getting Started | Session Info

1. **RTP Status:** The following bit positions indicate the connection status:
  - 0x10: receiving RTP packets (OK)
  - 0x01: wrong RTP sequence id
  - 0x02: wrong RTP SSRC
  - 0x04: wrong RTP payload type
  - 0x08: wrong RTP SAC
  - 0x20 stream has been muted
  - 0x40: Horus implementation - an incoming stream is muted

**Important Note:** The above error numbers are summed. For example, Stream Muted and Wrong Payload together are indicated by 0x24.

2. **Playout Delay:** This is the current playout delay on the selected sink in samples and ms.
3. **RTSP Host:** This is the connected source IP Session name: defined in SDP (usually the same as the source name)
4. **Clock Domain:** This is the PTP clock type and domain
5. **Payload:** Selections are Payload / Codec / Sampling Rate / Number of Channels
6. **SDP:** This displays detailed SDP information on the current stream.

## Getting Started | Ins/Outs

This tab allows you to change the name of the specific Inputs and/or Outputs.

Figure D-5: Getting Started | Ins/Outs

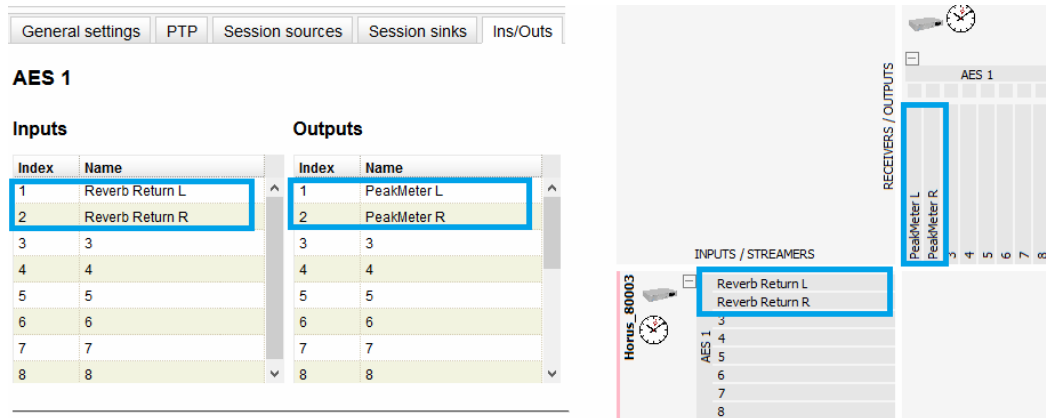

## Getting Started | I/O Router

This page allows remapping of incoming channels to different internal channel assignments. For example, Stream channel 1 can be remapped to Merging card Channel 0, and so on.

Figure D-6: Getting Started | I/O Router

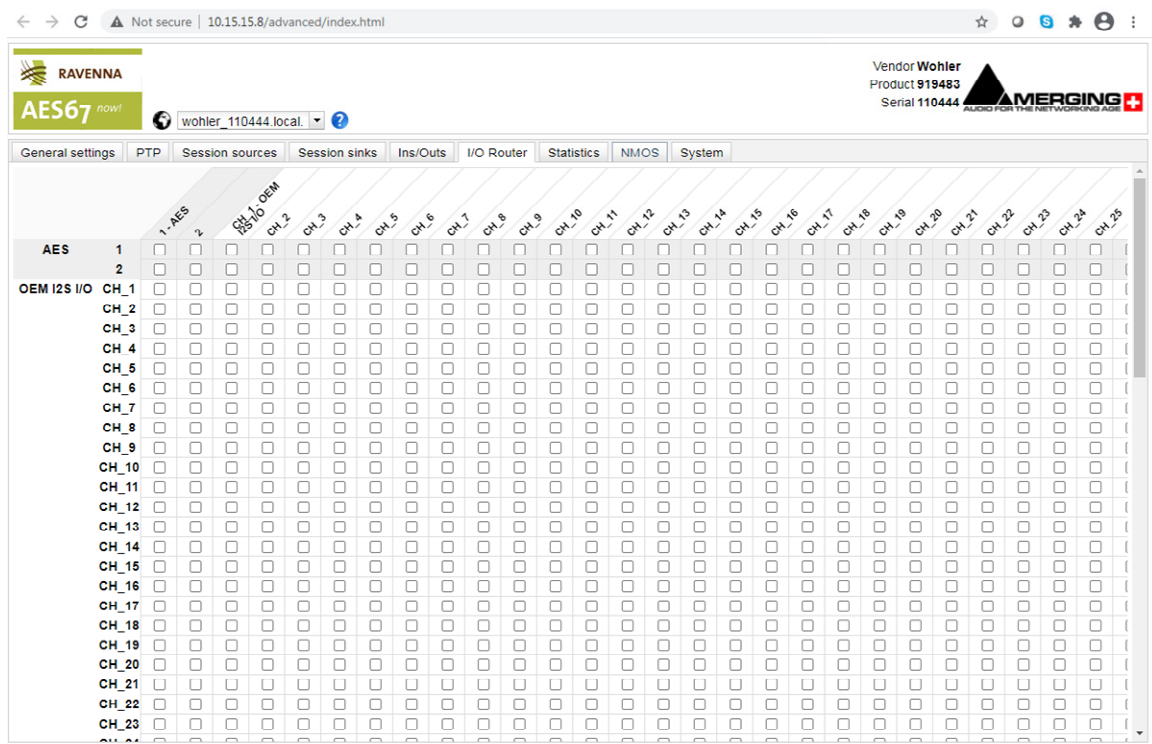

# Operation:

## Connecting Remote Source to Local Sink

This instruction assumes another Ravenna device is active on the network and sourcing a multicast stream. The Merging Configuration section for Session Sink controls how to configure the card to receive the stream and provide it to the IAM interface for display on meters and speakers, etc. The iAM-MIX must be set to receive AOIP from the Source Select Front Panel menu or a browser iAM-MIX GUI.

Ravenna Streams can contain up to 8 channels of information. The collections of channels in a specific Stream are termed Flows. For example, to source an SDI 16 channel signal might be accomplished by two Flows, each consisting of 8 channels. A stereo AES Flow consists of one Flow of two channels.

## ZMAN Session Sinks

This assumes that 1 or more sources are present on the AOIP Ravenna network. Right Select Advanced on the entry for the Merging ZMAN device in Aneman. This brings up the browser page with tab set to General configuration GUI for the ZMAN card. This is shown in Figure D-1.

Use the following procedure:

1. Select the **Session Sinks** tab and use the **Create Session Sinks** icon (in the upper left corner) to see the available source Flows.
2. Create an entry on the left panel for each source Flow to be configured.
3. Select the desired Flow and set the number of channels in the Flow. Select the desired range to direct the Flow to the internal channels of the iAM-MIX.
4. Click the matrix, as shown in Figure D-7, to direct the incoming channels to the desired iAM-MIX channels.

For example, a 16 channel SDI source consists of two 8 channel Flows. One could be mapped to channels 1-8 and the other could be mapped to 9-16.

Notice that the Tab I/O Router duplicates the Session Sinks matrix and can be used to map channels from input source assignments to iAM-MIX channels also.

Input channels can be mapped to more than one iAM-MIX channel by selecting additional matrix elements to map input channels 1-8 to both 1-8 and 9-16.

Figure D-7: Session Sinks Tab

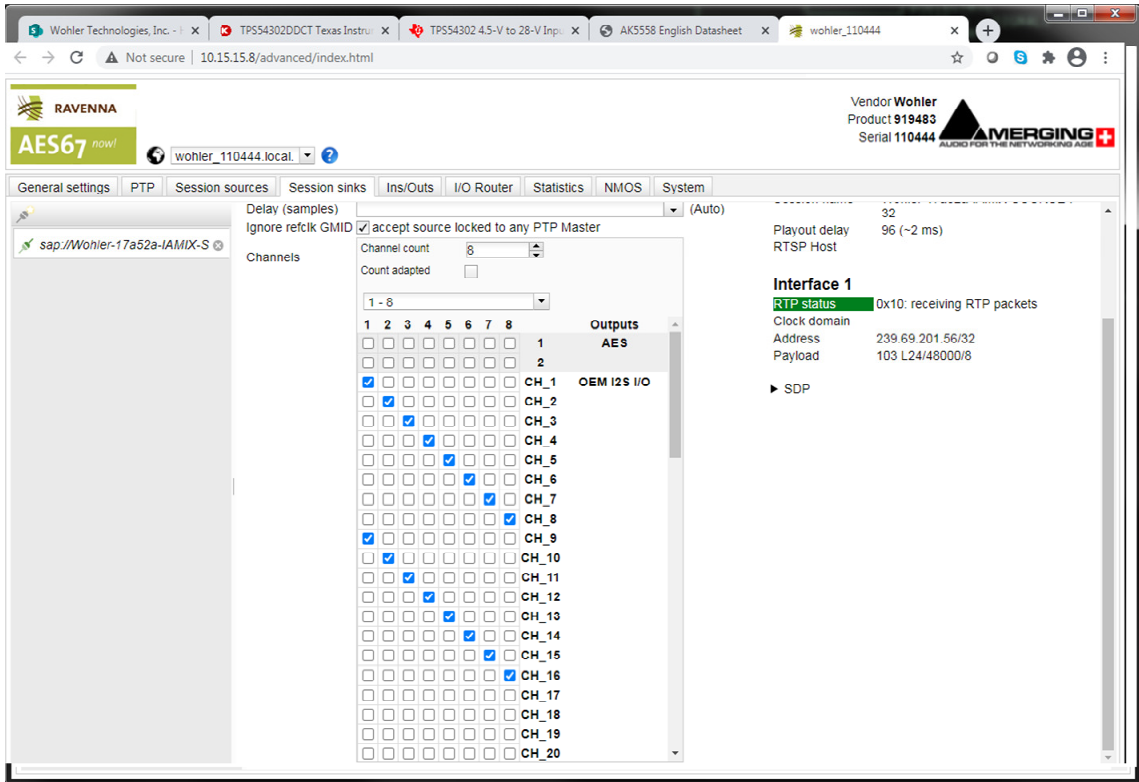

To avoid confusion if monitoring more than one Flow, especially if the various source Flows have overlapping channel numbers, use the matrix to direct Flows to higher channel ranges. For example, for monitoring 2 SDI sources (four 8 channel Flows), assign two flows to 1-8 and 9-16 and the next SDI signal to 17-24 and 25-32. Touch the iAM-MIX AOIP selection menu to select the proper range to monitor, up to 57-64.

Select **Apply** to enable the Sink process, which results in the meters and audio becoming available on the iAM-MIX.

## ZMAN Session Sources

If the ZMAN card is to Source Flows, use the **Session Sources** tab. Refer to Figure D-8. The procedure is similar to defining Sinks with the additional step to provide the Flow a name to appear on other units in the network. Select the channel range with a maximum of 8 channels per Flow.

Figure D-8: Session Sources Tab

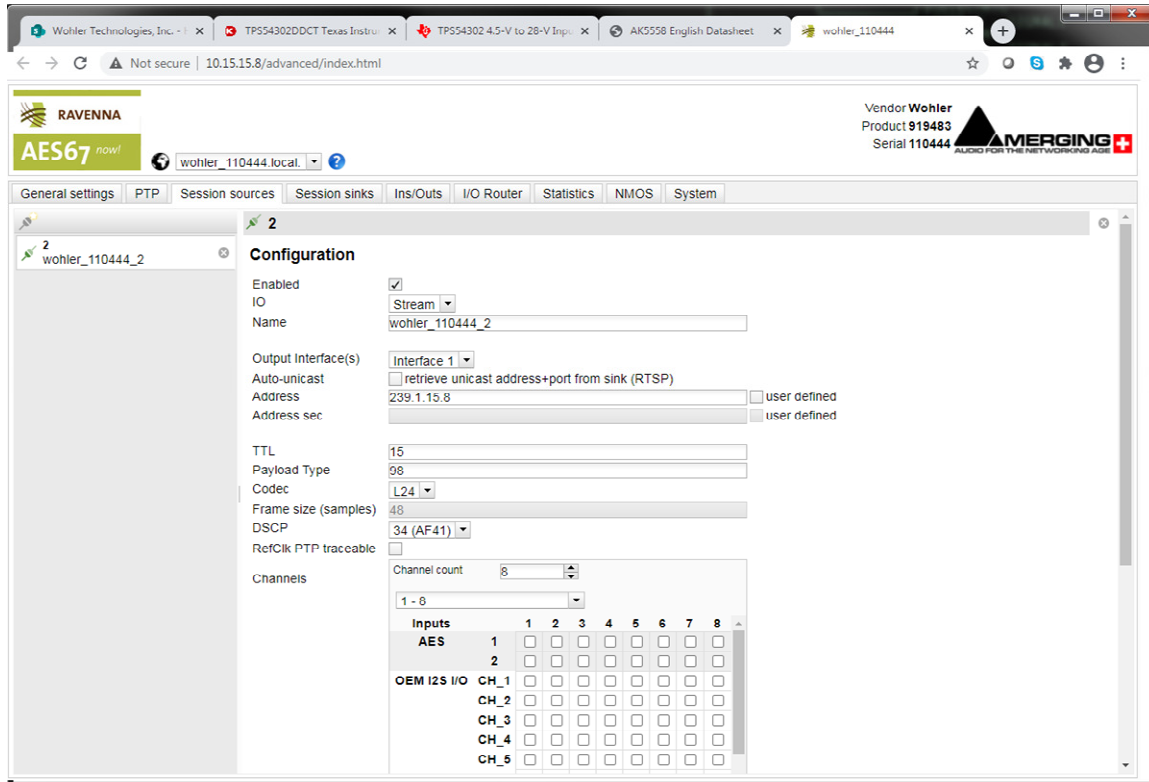

## ZMAN Updating

The Zman card is pre-initialized with the correct Wohler firmware load. In case of future upgrades, use the following steps:

1. In Aneman, right click the ZMAN entry on the bottom Devices section, and select Maintenance Mode. This brings up a web page which prompts for the location of the Wohler provided upgrade file. The file should resemble the following:

firmware\_1.1.7b43263\_18Jun20.wohler

2. Select this file and click Open. On the web, select Update to install the firmware.
3. After successful completion, select Reboot to reboot the ZMAN card.
4. Close the web pages and return to Aneman to set up Sources and Sinks.

# APPENDIX E: API Documentation

---

## Introduction

This appendix discusses ways to use the Application Program Interface (API) Version 2, which allows third party equipment to remotely access options and settings of the iAM-MIX. It includes specific code examples for commonly used requests. The API uses JavaScript Object Notation (JSON) as its communication language.

Follow the instructions in the **First Time IP Assignments** section of Chapter 4 to achieve the required network connection.

## API: Presets

**Get available presets:**

**Method: GET**

**URL: /api/cf/presets**

### Response JSON Object

- **string** **unit\_name:** Product Name ("IAM-ETZ-G4")
- **string** **model:** Product model ("iAM\_MIX\_IP")
- **string** **serial\_numbe** Product serial number
- **float** **api\_version:** REST API version
- **string** **result** List of Presets without configuration data.

### Status Codes:

- 200 OK
- 400 Bad Request Invalid URL
- 404 Data Not Found Invalid HTTP method request
- 500 Server Error Internal Server Error

**Example request:**

```
GET /api/cf/presets
```

**Example response:**

```
{
  "unit_name": "MIX-XHGCTV",
  "model": "iAM-Mix-IP",
  "api_version": 2,
  "serial_number": "123456",
  "result": [
    {
      "Favorite": 1,
      "Id": 1,
      "Name": "Preset Name 1"
    }
  ],
}
```

```
{
  "Favorite": 1,
  "Id": 2,
  "Name": "Preset Name 2"
},
{
  "Favorite": 1,
  "Id": 3,
  "Name": "Preset Name 3"
},
{
  "Favorite": 1,
  "Id": 4,
  "Name": "Preset Name 5"
},
{
  "Favorite": 1,
  "Id": 5,
  "Name": "Preset Name 6"
},
{
  "Favorite": 1,
  "Id": 6,
  "Name": "Preset Name 7"
},
{
  "Favorite": 1,
  "Id": 7,
  "Name": "Preset Name 8"
}
]
}
```



## Get preset information:

Method: GET

URL: /api/cf/presets/<int:preset ID>

URL parameters:

- preset ID -- preset ID (Number greater than zero)

### Response JSON Object

#### On Success

- string unit\_name: Product Name ("IAM-ETZ-G4")
- string model: Product model ("iAM\_MIX\_IP")
- string serial\_number: Product serial number
- float api\_version: REST API version
- string result: Preset with configuration data.

#### On Failure

- int status: HTTP status code.
- string action: Help message
- string message: Error message.

#### Status Codes:

- 200 OK
- 400 Bad Request Invalid URL
- 404 Data Not Found Invalid HTTP method request
- 500 Server Error Internal Server Error

### Example request:

```
GET /api/cf/presets/5
```

### Example response:

#### A. On Success:

```
{
  "unit_name": "iAM-Series",
  "model": "iAM-Mix-IP",
  "api_version": 2,
  "serial_number": "123456"
  "result": {
    "program": {
      "Id": "",
      "Name": "NoProgram"
    },
    "group": {
      "Id": "",
      "Name": "NoGroup"
    },
    "preset": {
      "Id": 5,
      "Name": "T-S-M-A",
      "Data": {
        "PresetConf": {
          "Cat1100Source": {
            "Pair": 0,
            "Type": "None"
          },
          "ApplyCor": false,
        }
      }
    }
  }
}
```

```

"MeterSet": {
  "1": {
    "VolumeDb": 0,
    "Source": {
      "Type": "Sfp-1.Sdi.Sdi-1",
      "Channel": 7
    },
    "DelayMs": 0,
    "Speaker": "Left",
    "Label": {
      "Default": true,
      "LabelType": 3,
      "LabelBottom": "7",
      "LabelTop": "SDI-1",
      "LabelID": "1"
    }
  },
  "2": {
    "VolumeDb": 0,
    "Source": {
      "Type": "Sfp-1.Sdi.Sdi-1",
      "Channel": 8
    },
    "DelayMs": 0,
    "Speaker": "Right",
    "Label": {
      "Default": true,
      "LabelType": 3,
      "LabelBottom": "8",
      "LabelTop": "SDI-1",
      "LabelID": "2"
    }
  },
  "3": {
    "VolumeDb": 0,
    "Source": {
      "Type": "Sfp-1.Sdi.Sdi-1",
      "Channel": 9
    },
    "DelayMs": 0,
    "Speaker": "Left",
    "Label": {
      "Default": true,
      "LabelType": 3,
      "LabelBottom": "9",
      "LabelTop": "SDI-1",
      "LabelID": "3"
    }
  },
  "4": {
    "VolumeDb": 0,
    "Source": {
      "Type": "Sfp-1.Sdi.Sdi-1",
      "Channel": 10
    },
    "DelayMs": 0,
    "Speaker": "Right",
    "Label": {
      "Default": true,
      "LabelType": 3,
      "LabelBottom": "10",
      "LabelTop": "SDI-1",
      "LabelID": "4"
    }
  },
  "5": {
    "VolumeDb": 0,
    "Source": {
      "Type": "Madi",
      "Channel": 5
    }
  }
}

```

```

    },
    "DelayMs": 0,
    "Speaker": "Left",
    "Label": {
        "Default": true,
        "LabelType": 3,
        "LabelBottom": "5",
        "LabelTop": "MADI",
        "LabelID": "5"
    }
},
"6": {
    "VolumeDb": 0,
    "Source": {
        "Type": "Madi",
        "Channel": 5
    },
    "DelayMs": 0,
    "Speaker": "Right",
    "Label": {
        "Default": true,
        "LabelType": 3,
        "LabelBottom": "5",
        "LabelTop": "MADI",
        "LabelID": "6"
    }
},
"7": {
    "VolumeDb": 0,
    "Source": {
        "Type": "Madi",
        "Channel": 5
    },
    "DelayMs": 0,
    "Speaker": "Left",
    "Label": {
        "Default": true,
        "LabelType": 3,
        "LabelBottom": "5",
        "LabelTop": "MADI",
        "LabelID": "7"
    }
},
"8": {
    "VolumeDb": 0,
    "Source": {
        "Type": "Madi",
        "Channel": 5
    },
    "DelayMs": 0,
    "Speaker": "Right",
    "Label": {
        "Default": true,
        "LabelType": 3,
        "LabelBottom": "5",
        "LabelTop": "MADI",
        "LabelID": "8"
    }
},
"9": {
    "VolumeDb": 0,
    "Source": {
        "Type": "Madi",
        "Channel": 5
    },
    "DelayMs": 0,
    "Speaker": "Left",
    "Label": {
        "Default": true,
        "LabelType": 3,

```

```

        "LabelBottom": "5",
        "LabelTop": "MADI",
        "LabelID": "9"
    },
    "10": {
        "VolumeDb": 0,
        "Source": {
            "Type": "Madi",
            "Channel": 5
        },
        "DelayMs": 0,
        "Speaker": "Right",
        "Label": {
            "Default": true,
            "LabelType": 3,
            "LabelBottom": "5",
            "LabelTop": "MADI",
            "LabelID": "10"
        }
    },
    "11": {
        "VolumeDb": 0,
        "Source": {
            "Type": "Aes",
            "Channel": 1
        },
        "DelayMs": 0,
        "Speaker": "Left",
        "Label": {
            "Default": true,
            "LabelType": 3,
            "LabelBottom": "1",
            "LabelTop": "AES",
            "LabelID": "11"
        }
    },
    "12": {
        "VolumeDb": 0,
        "Source": {
            "Type": "Aes",
            "Channel": 2
        },
        "DelayMs": 0,
        "Speaker": "Right",
        "Label": {
            "Default": true,
            "LabelType": 3,
            "LabelBottom": "2",
            "LabelTop": "AES",
            "LabelID": "12"
        }
    },
    "13": {
        "VolumeDb": 0,
        "Source": {
            "Type": "Aes",
            "Channel": 3
        },
        "DelayMs": 0,
        "Speaker": "Left",
        "Label": {
            "Default": true,
            "LabelType": 3,
            "LabelBottom": "3",
            "LabelTop": "AES",
            "LabelID": "13"
        }
    },
    "14": {

```

```

        "VolumeDb": 0,
        "Source": {
            "Type": "Aes",
            "Channel": 4
        },
        "DelayMs": 0,
        "Speaker": "Right",
        "Label": {
            "Default": true,
            "LabelType": 3,
            "LabelBottom": "4",
            "LabelTop": "AES",
            "LabelID": "14"
        }
    },
    "15": {
        "VolumeDb": 0,
        "Source": {
            "Type": "Aes",
            "Channel": 5
        },
        "DelayMs": 0,
        "Speaker": "Left",
        "Label": {
            "Default": true,
            "LabelType": 3,
            "LabelBottom": "5",
            "LabelTop": "AES",
            "LabelID": "15"
        }
    },
    "16": {
        "VolumeDb": 0,
        "Source": {
            "Type": "Aes",
            "Channel": 6
        },
        "DelayMs": 0,
        "Speaker": "Right",
        "Label": {
            "Default": true,
            "LabelType": 3,
            "LabelBottom": "6",
            "LabelTop": "AES",
            "LabelID": "16"
        }
    }
},
"MadiExpectedType": "Coax",
"VideoSource": {},
"DolbySetup": {
    "VsyncMute": "Disable",
    "VideoSyncSource": "None",
    "Dd+LatencyMode": "2Frames",
    "StreamMutes": {
        "Dd+": "Decode",
        "Dd": "Decode",
        "De": "Decode",
        "Pcm": "Pass"
    }
},
"DeOnAirMode": "Enable",
"Type": "None",
"EmulationModeMainOut": "LineMode",
"FrameSync": "Disable",
"EmulationModeDownmixOut": "LineMode",
"DeProgramSelect": 1,
"Pair": 0,
"DownmixOutputMixMode": "Auto",
"VsyncAlign": "Disable",
"Dd+MixMode": "Mixed",

```

```

        "ConfidenceDecode": "Disable",
        "CrcErrorCount": "Enable"
    },
    "ConfVersion": 1,
    "AudioOutputRouting": {
        "OutputTypes": {
            "Aoip.Pair-31": {
                "OutputChannels": [
                    {
                        "OutputTrimDb": 0,
                        "MeterSources": [
                            1,
                            3,
                            5,
                            7,
                            9,
                            11,
                            13,
                            15
                        ],
                        "Speaker": "L"
                    },
                    {
                        "OutputTrimDb": 0,
                        "MeterSources": [
                            2,
                            4,
                            6,
                            8,
                            10,
                            12,
                            14,
                            16
                        ],
                        "Speaker": "R"
                    }
                ],
                "MasterVolume": true,
                "SpeakerArrangement": "None",
                "SoloMute": true,
                "HeadphoneMute": true,
                "SpeakerMix": true,
                "AutoRoute": false
            },
            "Aoip.Pair-30": {
                "OutputChannels": [
                    {
                        "OutputTrimDb": 0,
                        "MeterSources": [
                            1,
                            3,
                            5,
                            7,
                            9,
                            11,
                            13,
                            15
                        ],
                        "Speaker": "L"
                    },
                    {
                        "OutputTrimDb": 0,
                        "MeterSources": [
                            2,
                            4,
                            6,
                            8,
                            10,
                            12,
                            14,

```

```

        16
    ],
    "Speaker": "R"
}
],
"MasterVolume": true,
"SpeakerArrangement": "None",
"SoloMute": true,
"HeadphoneMute": true,
"SpeakerMix": true,
"AutoRoute": false
},
"SpeakerHeadphone": {
    "OutputChannels": [
        {
            "OutputTrimDb": 0,
            "MeterSources": [
                1,
                3,
                5,
                7,
                9,
                11,
                13,
                15
            ],
            "Speaker": "L"
        },
        {
            "OutputTrimDb": 0,
            "MeterSources": [
                2,
                4,
                6,
                8,
                10,
                12,
                14,
                16
            ],
            "Speaker": "R"
        }
    ],
    "MasterVolume": true,
    "SpeakerArrangement": "None",
    "SoloMute": true,
    "HeadphoneMute": true,
    "SpeakerMix": true,
    "AutoRoute": false
},
"AnalogXlr": {
    "OutputChannels": [
        {
            "OutputTrimDb": 0,
            "MeterSources": [
                1,
                3,
                5,
                7,
                9,
                11,
                13,
                15
            ],
            "Speaker": "L"
        },
        {
            "OutputTrimDb": 0,
            "MeterSources": [
                2,

```

```

        4,
        6,
        8,
        10,
        12,
        14,
        16
    ],
    "Speaker": "R"
}
],
"MasterVolume": true,
"SpeakerArrangement": "None",
"SoloMute": true,
"HeadphoneMute": true,
"SpeakerMix": true,
"AutoRoute": false
},
"Aes.Pair-4": {
    "OutputChannels": [
        {
            "OutputTrimDb": 0,
            "MeterSources": [
                1,
                3,
                5,
                7,
                9,
                11,
                13,
                15
            ],
            "Speaker": "L"
        },
        {
            "OutputTrimDb": 0,
            "MeterSources": [
                2,
                4,
                6,
                8,
                10,
                12,
                14,
                16
            ],
            "Speaker": "R"
        }
    ],
    "MasterVolume": true,
    "SpeakerArrangement": "None",
    "SoloMute": true,
    "HeadphoneMute": true,
    "SpeakerMix": true,
    "AutoRoute": false
},
"Aes.Pair-1": {
    "OutputChannels": [
        {
            "OutputTrimDb": 0,
            "MeterSources": [
                1,
                3,
                5,
                7,
                9,
                11,
                13,
                15
            ],

```



```

        "Speaker": "L"
    },
    {
        "OutputTrimDb": 0,
        "MeterSources": [
            2,
            4,
            6,
            8,
            10,
            12,
            14,
            16
        ],
        "Speaker": "R"
    }
],
"MasterVolume": true,
"SpeakerArrangement": "None",
"SoloMute": true,
"HeadphoneMute": true,
"SpeakerMix": true,
"AutoRoute": false
},
"Aes.Pair-2": {
    "OutputChannels": [
        {
            "OutputTrimDb": 0,
            "MeterSources": [
                1,
                3,
                5,
                7,
                9,
                11,
                13,
                15
            ],
            "Speaker": "L"
        },
        {
            "OutputTrimDb": 0,
            "MeterSources": [
                2,
                4,
                6,
                8,
                10,
                12,
                14,
                16
            ],
            "Speaker": "R"
        }
    ],
    "MasterVolume": true,
    "SpeakerArrangement": "None",
    "SoloMute": true,
    "HeadphoneMute": true,
    "SpeakerMix": true,
    "AutoRoute": false
},
"Aes.Pair-3": {
    "OutputChannels": [
        {
            "OutputTrimDb": 0,
            "MeterSources": [
                1,
                3,
                5,

```

```

        7,
        9,
        11,
        13,
        15
    ],
    "Speaker": "L"
},
{
    "OutputTrimDb": 0,
    "MeterSources": [
        2,
        4,
        6,
        8,
        10,
        12,
        14,
        16
    ],
    "Speaker": "R"
}
},
"MasterVolume": true,
"SpeakerArrangement": "None",
"SoloMute": true,
"HeadphoneMute": true,
"SpeakerMix": true,
"AutoRoute": false
}
},
"SystemClockSource": {
    "Pair": 0,
    "Type": "Sfp-1"
},
"SpeakerOptions": {
    "DelayMs": 0
},
"Clusters": [
    {
        "NumberOfMeters": 1,
        "MuteOnPresetRecall": true,
        "Type": "Mono",
        "Name": "Mono 1.0 #1",
        "FirstMeter": 1
    },
    {
        "NumberOfMeters": 1,
        "MuteOnPresetRecall": true,
        "Type": "Mono",
        "Name": "Mono 1.0 #2",
        "FirstMeter": 2
    },
    {
        "NumberOfMeters": 1,
        "MuteOnPresetRecall": true,
        "Type": "Mono",
        "Name": "Mono 1.0 #3",
        "FirstMeter": 3
    },
    {
        "NumberOfMeters": 1,
        "MuteOnPresetRecall": true,
        "Type": "Mono",
        "Name": "Mono 1.0 #4",
        "FirstMeter": 4
    },
    {
        "NumberOfMeters": 1,

```

```

    "MuteOnPresetRecall": true,
    "Type": "Mono",
    "Name": "Mono 1.0 #5",
    "FirstMeter": 5
  },
  {
    "NumberOfMeters": 1,
    "MuteOnPresetRecall": true,
    "Type": "Mono",
    "Name": "Mono 1.0 #6",
    "FirstMeter": 6
  },
  {
    "NumberOfMeters": 1,
    "MuteOnPresetRecall": true,
    "Type": "Mono",
    "Name": "Mono 1.0 #7",
    "FirstMeter": 7
  },
  {
    "NumberOfMeters": 1,
    "MuteOnPresetRecall": true,
    "Type": "Mono",
    "Name": "Mono 1.0 #8",
    "FirstMeter": 8
  },
  {
    "NumberOfMeters": 1,
    "MuteOnPresetRecall": true,
    "Type": "Mono",
    "Name": "Mono 1.0 #9",
    "FirstMeter": 9
  },
  {
    "NumberOfMeters": 1,
    "MuteOnPresetRecall": true,
    "Type": "Mono",
    "Name": "Mono 1.0 #10",
    "FirstMeter": 10
  },
  {
    "NumberOfMeters": 1,
    "MuteOnPresetRecall": true,
    "Type": "Mono",
    "Name": "Mono 1.0 #11",
    "FirstMeter": 11
  },
  {
    "NumberOfMeters": 1,
    "MuteOnPresetRecall": true,
    "Type": "Mono",
    "Name": "Mono 1.0 #12",
    "FirstMeter": 12
  },
  {
    "NumberOfMeters": 1,
    "MuteOnPresetRecall": true,
    "Type": "Mono",
    "Name": "Mono 1.0 #13",
    "FirstMeter": 13
  },
  {
    "NumberOfMeters": 1,
    "MuteOnPresetRecall": true,
    "Type": "Mono",
    "Name": "Mono 1.0 #14",
    "FirstMeter": 14
  },
  {
    "NumberOfMeters": 1,

```

```

        "MuteOnPresetRecall": true,
        "Type": "Mono",
        "Name": "Mono 1.0 #15",
        "FirstMeter": 15
    },
    {
        "NumberOfMeters": 1,
        "MuteOnPresetRecall": true,
        "Type": "Mono",
        "Name": "Mono 1.0 #16",
        "FirstMeter": 16
    }
],
"MeterPreferences": {
    "muteMasterVolume": false,
    "masterVolume": false
},
>Name": {
    "Preset": "T-S-M-A",
    "Program": "NoProgram",
    "Group": "NoGroup"
}
},
"InputSrcList": {
    "inputClockRefPair": 1,
    "meters": {
        "1": {
            "parentInput": "SFP-1.SDI.SDI-1"
        },
        "2": {
            "parentInput": "SFP-1.SDI.SDI-1"
        },
        "3": {
            "parentInput": "SFP-1.SDI.SDI-1"
        },
        "4": {
            "parentInput": "SFP-1.SDI.SDI-1"
        },
        "5": {
            "parentInput": "MADI"
        },
        "6": {
            "parentInput": "MADI"
        },
        "7": {
            "parentInput": "MADI"
        },
        "8": {
            "parentInput": "MADI"
        },
        "9": {
            "parentInput": "MADI"
        },
        "10": {
            "parentInput": "MADI"
        },
        "11": {
            "parentInput": "AES"
        },
        "12": {
            "parentInput": "AES"
        },
        "13": {
            "parentInput": "AES"
        },
        "14": {
            "parentInput": "AES"
        },
        "15": {
            "parentInput": "AES"
        }
    }
}

```

```
        },
        "16": {
            "parentInput": "AES"
        }
    },
    "Dolby": {
        "VideoSyncSource": "None",
        "DolbyChannelsSource": "None"
    },
    "inputClockRef": "SFP-1"
}
}
}
}
}
```

B. On Failure:

```
{
  "status": 404,
  "action": "For more information about preset, please see API
            document.",
  "message": "Preset not found for Id: 5"
}
```

## Get preset information:

**Method: GET**

**URL: /api/cf/presets/presetbyname/<str:preset Name>**

**URL parameters:**

- **preset Name** -- preset Name (String maximum length: 10). *The preset name is case sensitive.*

### Response JSON Object

#### On Success

- **string** **unit\_name:** Product Name ("IAM-ETZ-G4")
- **string** **model:** Product model ("iAM\_MIX\_IP")
- **string** **serial\_number:** Product serial number
- **float** **api\_version:** REST API version
- **string** **presets:** List of Presets with configuration data.

#### On Failure

- **integer** **status:** HTTP status code.
- **string** **action:** Help message
- **string** **message:** Error message.

#### Status Codes:

- 200 OK
- 400 Bad Request Invalid URL
- 404 Data Not Found Invalid HTTP method request
- 500 Server Error Internal Server Error

### Example request:

```
GET /api/cf/presets/presetbyname/T-S-M-A
```

### Example response:

#### A. On Success:

```
{
  "unit_name": "iAM-Series",
  "serial_number": "123456",
  "model": "iAM-Mix-IP",
  "api_version": 2,
  "result": {
    "Cat1100Source": {
      "Pair": 0,
      "Type": "None"
    },
    "ApplyCor": false,
    "MeterSet": {
      "1": {
        "VolumeDb": 0,
        "Source": {
          "Type": "Sfp-1.Sdi.Sdi-1",
          "Channel": 7
        },
        "DelayMs": 0,
        "Speaker": "Left",
        "Label": {
          "Default": true,
          "LabelType": 3,
          "LabelBottom": "7",

```

```

        "LabelTop": "SDI-1",
        "LabelID": "1"
    }
},
"2": {
    "VolumeDb": 0,
    "Source": {
        "Type": "Sfp-1.Sdi.Sdi-1",
        "Channel": 8
    },
    "DelayMs": 0,
    "Speaker": "Right",
    "Label": {
        "Default": true,
        "LabelType": 3,
        "LabelBottom": "8",
        "LabelTop": "SDI-1",
        "LabelID": "2"
    }
},
"3": {
    "VolumeDb": 0,
    "Source": {
        "Type": "Sfp-1.Sdi.Sdi-1",
        "Channel": 9
    },
    "DelayMs": 0,
    "Speaker": "Left",
    "Label": {
        "Default": true,
        "LabelType": 3,
        "LabelBottom": "9",
        "LabelTop": "SDI-1",
        "LabelID": "3"
    }
},
"4": {
    "VolumeDb": 0,
    "Source": {
        "Type": "Sfp-1.Sdi.Sdi-1",
        "Channel": 10
    },
    "DelayMs": 0,
    "Speaker": "Right",
    "Label": {
        "Default": true,
        "LabelType": 3,
        "LabelBottom": "10",
        "LabelTop": "SDI-1",
        "LabelID": "4"
    }
},
"5": {
    "VolumeDb": 0,
    "Source": {
        "Type": "Madi",
        "Channel": 5
    },
    "DelayMs": 0,
    "Speaker": "Left",
    "Label": {
        "Default": true,
        "LabelType": 3,
        "LabelBottom": "5",
        "LabelTop": "MADI",
        "LabelID": "5"
    }
},
"6": {
    "VolumeDb": 0,

```

```

"Source": {
  "Type": "Madi",
  "Channel": 5
},
"DelayMs": 0,
"Speaker": "Right",
"Label": {
  "Default": true,
  "LabelType": 3,
  "LabelBottom": "5",
  "LabelTop": "MADI",
  "LabelID": "6"
}
},
"7": {
  "VolumeDb": 0,
  "Source": {
    "Type": "Madi",
    "Channel": 5
  },
  "DelayMs": 0,
  "Speaker": "Left",
  "Label": {
    "Default": true,
    "LabelType": 3,
    "LabelBottom": "5",
    "LabelTop": "MADI",
    "LabelID": "7"
  }
},
"8": {
  "VolumeDb": 0,
  "Source": {
    "Type": "Madi",
    "Channel": 5
  },
  "DelayMs": 0,
  "Speaker": "Right",
  "Label": {
    "Default": true,
    "LabelType": 3,
    "LabelBottom": "5",
    "LabelTop": "MADI",
    "LabelID": "8"
  }
},
"9": {
  "VolumeDb": 0,
  "Source": {
    "Type": "Madi",
    "Channel": 5
  },
  "DelayMs": 0,
  "Speaker": "Left",
  "Label": {
    "Default": true,
    "LabelType": 3,
    "LabelBottom": "5",
    "LabelTop": "MADI",
    "LabelID": "9"
  }
},
"10": {
  "VolumeDb": 0,
  "Source": {
    "Type": "Madi",
    "Channel": 5
  },
  "DelayMs": 0,
  "Speaker": "Right",

```



```

    "Label": {
      "Default": true,
      "LabelType": 3,
      "LabelBottom": "5",
      "LabelTop": "MADI",
      "LabelID": "10"
    }
  },
  "11": {
    "VolumeDb": 0,
    "Source": {
      "Type": "Aes",
      "Channel": 1
    },
    "DelayMs": 0,
    "Speaker": "Left",
    "Label": {
      "Default": true,
      "LabelType": 3,
      "LabelBottom": "1",
      "LabelTop": "AES",
      "LabelID": "11"
    }
  },
  "12": {
    "VolumeDb": 0,
    "Source": {
      "Type": "Aes",
      "Channel": 2
    },
    "DelayMs": 0,
    "Speaker": "Right",
    "Label": {
      "Default": true,
      "LabelType": 3,
      "LabelBottom": "2",
      "LabelTop": "AES",
      "LabelID": "12"
    }
  },
  "13": {
    "VolumeDb": 0,
    "Source": {
      "Type": "Aes",
      "Channel": 3
    },
    "DelayMs": 0,
    "Speaker": "Left",
    "Label": {
      "Default": true,
      "LabelType": 3,
      "LabelBottom": "3",
      "LabelTop": "AES",
      "LabelID": "13"
    }
  },
  "14": {
    "VolumeDb": 0,
    "Source": {
      "Type": "Aes",
      "Channel": 4
    },
    "DelayMs": 0,
    "Speaker": "Right",
    "Label": {
      "Default": true,
      "LabelType": 3,
      "LabelBottom": "4",
      "LabelTop": "AES",
      "LabelID": "14"
    }
  }
}

```

```

    },
    "15": {
      "VolumeDb": 0,
      "Source": {
        "Type": "Aes",
        "Channel": 5
      },
      "DelayMs": 0,
      "Speaker": "Left",
      "Label": {
        "Default": true,
        "LabelType": 3,
        "LabelBottom": "5",
        "LabelTop": "AES",
        "LabelID": "15"
      }
    },
    "16": {
      "VolumeDb": 0,
      "Source": {
        "Type": "Aes",
        "Channel": 6
      },
      "DelayMs": 0,
      "Speaker": "Right",
      "Label": {
        "Default": true,
        "LabelType": 3,
        "LabelBottom": "6",
        "LabelTop": "AES",
        "LabelID": "16"
      }
    }
  },
  "MadiExpectedType": "Coax",
  "VideoSource": {},
  "DolbySetup": {
    "VsyncMute": "Disable",
    "VideoSyncSource": "None",
    "Dd+LatencyMode": "2Frames",
    "StreamMutes": {
      "Dd+": "Decode",
      "Dd": "Decode",
      "De": "Decode",
      "Pcm": "Pass"
    },
    "DeOnAirMode": "Enable",
    "Type": "None",
    "EmulationModeMainOut": "LineMode",
    "FrameSync": "Disable",
    "EmulationModeDownmixOut": "LineMode",
    "DeProgramSelect": 1,
    "Pair": 0,
    "DownmixOutputMixMode": "Auto",
    "VsyncAlign": "Disable",
    "Dd+MixMode": "Mixed",
    "ConfidenceDecode": "Disable",
    "CrcErrorCount": "Enable"
  },
  "ConfVersion": 1,
  "AudioOutputRouting": {
    "OutputTypes": {
      "Aoip.Pair-31": {
        "OutputChannels": [
          {
            "OutputTrimDb": 0,
            "MeterSources": [
              1,
              3,
            ]
          }
        ]
      }
    }
  }
}

```

```

        5,
        7,
        9,
        11,
        13,
        15
    ],
    "Speaker": "L"
},
{
    "OutputTrimDb": 0,
    "MeterSources": [
        2,
        4,
        6,
        8,
        10,
        12,
        14,
        16
    ],
    "Speaker": "R"
}
],
"MasterVolume": true,
"SpeakerArrangement": "None",
"SoloMute": true,
"HeadphoneMute": true,
"SpeakerMix": true,
"AutoRoute": false
},
"Aoip.Pair-30": {
    "OutputChannels": [
        {
            "OutputTrimDb": 0,
            "MeterSources": [
                1,
                3,
                5,
                7,
                9,
                11,
                13,
                15
            ],
            "Speaker": "L"
        },
        {
            "OutputTrimDb": 0,
            "MeterSources": [
                2,
                4,
                6,
                8,
                10,
                12,
                14,
                16
            ],
            "Speaker": "R"
        }
    ],
    "MasterVolume": true,
    "SpeakerArrangement": "None",
    "SoloMute": true,
    "HeadphoneMute": true,
    "SpeakerMix": true,
    "AutoRoute": false
},
"SpeakerHeadphone": {

```

```

"OutputChannels": [
  {
    "OutputTrimDb": 0,
    "MeterSources": [
      1,
      3,
      5,
      7,
      9,
      11,
      13,
      15
    ],
    "Speaker": "L"
  },
  {
    "OutputTrimDb": 0,
    "MeterSources": [
      2,
      4,
      6,
      8,
      10,
      12,
      14,
      16
    ],
    "Speaker": "R"
  }
],
"MasterVolume": true,
"SpeakerArrangement": "None",
"SoloMute": true,
"HeadphoneMute": true,
"SpeakerMix": true,
"AutoRoute": false
},
"AnalogXlr": {
  "OutputChannels": [
    {
      "OutputTrimDb": 0,
      "MeterSources": [
        1,
        3,
        5,
        7,
        9,
        11,
        13,
        15
      ],
      "Speaker": "L"
    },
    {
      "OutputTrimDb": 0,
      "MeterSources": [
        2,
        4,
        6,
        8,
        10,
        12,
        14,
        16
      ],
      "Speaker": "R"
    }
  ],
  "MasterVolume": true,
  "SpeakerArrangement": "None",

```

```

        "SoloMute": true,
        "HeadphoneMute": true,
        "SpeakerMix": true,
        "AutoRoute": false
    },
    "Aes.Pair-4": {
        "OutputChannels": [
            {
                "OutputTrimDb": 0,
                "MeterSources": [
                    1,
                    3,
                    5,
                    7,
                    9,
                    11,
                    13,
                    15
                ],
                "Speaker": "L"
            },
            {
                "OutputTrimDb": 0,
                "MeterSources": [
                    2,
                    4,
                    6,
                    8,
                    10,
                    12,
                    14,
                    16
                ],
                "Speaker": "R"
            }
        ],
        "MasterVolume": true,
        "SpeakerArrangement": "None",
        "SoloMute": true,
        "HeadphoneMute": true,
        "SpeakerMix": true,
        "AutoRoute": false
    },
    "Aes.Pair-1": {
        "OutputChannels": [
            {
                "OutputTrimDb": 0,
                "MeterSources": [
                    1,
                    3,
                    5,
                    7,
                    9,
                    11,
                    13,
                    15
                ],
                "Speaker": "L"
            },
            {
                "OutputTrimDb": 0,
                "MeterSources": [
                    2,
                    4,
                    6,
                    8,
                    10,
                    12,
                    14,
                    16
                ],
                "Speaker": "R"
            }
        ],
        "MasterVolume": true,
        "SpeakerArrangement": "None",
        "SoloMute": true,
        "HeadphoneMute": true,
        "SpeakerMix": true,
        "AutoRoute": false
    }
}

```

```

        ],
        "Speaker": "R"
    }
],
"MasterVolume": true,
"SpeakerArrangement": "None",
"SoloMute": true,
"HeadphoneMute": true,
"SpeakerMix": true,
"AutoRoute": false
},
"Aes.Pair-2": {
    "OutputChannels": [
        {
            "OutputTrimDb": 0,
            "MeterSources": [
                1,
                3,
                5,
                7,
                9,
                11,
                13,
                15
            ],
            "Speaker": "L"
        },
        {
            "OutputTrimDb": 0,
            "MeterSources": [
                2,
                4,
                6,
                8,
                10,
                12,
                14,
                16
            ],
            "Speaker": "R"
        }
    ],
    "MasterVolume": true,
    "SpeakerArrangement": "None",
    "SoloMute": true,
    "HeadphoneMute": true,
    "SpeakerMix": true,
    "AutoRoute": false
},
"Aes.Pair-3": {
    "OutputChannels": [
        {
            "OutputTrimDb": 0,
            "MeterSources": [
                1,
                3,
                5,
                7,
                9,
                11,
                13,
                15
            ],
            "Speaker": "L"
        },
        {
            "OutputTrimDb": 0,
            "MeterSources": [
                2,
                4,

```

```

        6,
        8,
        10,
        12,
        14,
        16
    ],
    "Speaker": "R"
}
],
"MasterVolume": true,
"SpeakerArrangement": "None",
"SoloMute": true,
"HeadphoneMute": true,
"SpeakerMix": true,
"AutoRoute": false
}
},
"SystemClockSource": {
    "Pair": 0,
    "Type": "Sfp-1"
},
"SpeakerOptions": {
    "DelayMs": 0
},
"Clusters": [
    {
        "NumberOfMeters": 1,
        "MuteOnPresetRecall": true,
        "Type": "Mono",
        "Name": "Mono 1.0 #1",
        "FirstMeter": 1
    },
    {
        "NumberOfMeters": 1,
        "MuteOnPresetRecall": true,
        "Type": "Mono",
        "Name": "Mono 1.0 #2",
        "FirstMeter": 2
    },
    {
        "NumberOfMeters": 1,
        "MuteOnPresetRecall": true,
        "Type": "Mono",
        "Name": "Mono 1.0 #3",
        "FirstMeter": 3
    },
    {
        "NumberOfMeters": 1,
        "MuteOnPresetRecall": true,
        "Type": "Mono",
        "Name": "Mono 1.0 #4",
        "FirstMeter": 4
    },
    {
        "NumberOfMeters": 1,
        "MuteOnPresetRecall": true,
        "Type": "Mono",
        "Name": "Mono 1.0 #5",
        "FirstMeter": 5
    },
    {
        "NumberOfMeters": 1,
        "MuteOnPresetRecall": true,
        "Type": "Mono",
        "Name": "Mono 1.0 #6",
        "FirstMeter": 6
    }
]
}

```

```

        "NumberOfMeters": 1,
        "MuteOnPresetRecall": true,
        "Type": "Mono",
        "Name": "Mono 1.0 #7",
        "FirstMeter": 7
    },
    {
        "NumberOfMeters": 1,
        "MuteOnPresetRecall": true,
        "Type": "Mono",
        "Name": "Mono 1.0 #8",
        "FirstMeter": 8
    },
    {
        "NumberOfMeters": 1,
        "MuteOnPresetRecall": true,
        "Type": "Mono",
        "Name": "Mono 1.0 #9",
        "FirstMeter": 9
    },
    {
        "NumberOfMeters": 1,
        "MuteOnPresetRecall": true,
        "Type": "Mono",
        "Name": "Mono 1.0 #10",
        "FirstMeter": 10
    },
    {
        "NumberOfMeters": 1,
        "MuteOnPresetRecall": true,
        "Type": "Mono",
        "Name": "Mono 1.0 #11",
        "FirstMeter": 11
    },
    {
        "NumberOfMeters": 1,
        "MuteOnPresetRecall": true,
        "Type": "Mono",
        "Name": "Mono 1.0 #12",
        "FirstMeter": 12
    },
    {
        "NumberOfMeters": 1,
        "MuteOnPresetRecall": true,
        "Type": "Mono",
        "Name": "Mono 1.0 #13",
        "FirstMeter": 13
    },
    {
        "NumberOfMeters": 1,
        "MuteOnPresetRecall": true,
        "Type": "Mono",
        "Name": "Mono 1.0 #14",
        "FirstMeter": 14
    },
    {
        "NumberOfMeters": 1,
        "MuteOnPresetRecall": true,
        "Type": "Mono",
        "Name": "Mono 1.0 #15",
        "FirstMeter": 15
    },
    {
        "NumberOfMeters": 1,
        "MuteOnPresetRecall": true,
        "Type": "Mono",
        "Name": "Mono 1.0 #16",
        "FirstMeter": 16
    }
},

```



```
        "MeterPreferences": {
            "muteMasterVolume": false,
            "masterVolume": false
        },
        "Name": {
            "Preset": "",
            "Program": "",
            "Group": ""
        }
    }
}
```

B. On Failure:

```
{
    "status": 404,
    "action": "For more information about preset, please see API
              document",
    "message": "Preset 'IAM-ETZ-G41' was not found"
}
```

## Get current active preset

**Method: GET**  
**URL: /api/cf/presets/current**

### Response JSON Object

- **string** **unit\_name:** Product Name ("IAM-ETZ-G4")
- **string** **model:** Product model ("IAM\_MIX\_IP")
- **string** **serial\_number:** Product serial number
- **float** **api\_version:** REST API version
- **string** **result:** Preset information without configuration data.

### Status Codes:

- 200 OK
- 400 Bad Request Invalid URL
- 404 Data Not Found Invalid HTTP method request
- 500 Server Error Internal Server Error

### Example request:

```
GET /api/cf/presets/current
```

### Example response:

```
{
  "unit_name": "iAM-Series",
  "model": "iAM-Mix-IP",
  "api_version": 2,
  "serial_number": "123456",
  "result": {
    "preset": {
      "Id": 5,
      "Name": "T-S-M-A"
    }
  }
}
```

## Preset Activation

Method: PATCH

URL: /api/cf/presets/<int:preset ID>/activate

URL parameters:

- preset ID -- preset ID (Number greater than zero)

### Response JSON Object

#### On Success

• string	unit_name:	Product Name ("IAM-ETZ-G4")
• string	model:	Product model ("IAM_MIX_IP")
• string	serial_number:	Product serial number
• float	api_version:	REST API version
• string	warning:	Message
• string	message:	Message
• integer	status:	HTTP status code

#### On Failure

• integer	status:	HTTP status code.
• string	action:	Help message
• string	message:	Error message.

#### Status Codes:

• 200	OK	Request accepted for processing
• 400	Bad Request	Invalid URL
• 404	Data Not Found	Invalid HTTP method request
• 500	Server Error	Internal Server Error

### Example request:

```
PATCH /api/cf/presets/5/activate
```

### Example response:

#### A. On Success:

```
{
  "status": 200,
  "unit_name": "iAM-Series",
  "api_version": 2,
  "warning": "",
  "serial_number": "123456",
  "model": "iAM-Mix-IP",
  "message": "Preset 5:T-S-M-A is set for recall"
}
```

#### B. On Failure:

```
{
  "status": 404,
  "action": "For more information about preset recall, please see API
  document.",
  "message": "Preset not found for Id: 55"
}
```

# Setting Solo Meter

## Method: PATCH

### URL: /api/op/presets/mute-meters

#### URL parameters:

- **data** Data in JSON format.

#### Request

- **Headers**
  - Accept:** application/json
  - Content-Type:** application/json

#### Response JSON Object

##### On Success

- **string** **unit\_name:** Product Name ("IAM-ETZ-G4")
- **string** **model:** Product model ("iAM\_MIX\_IP")
- **string** **serial\_number:** Product serial number
- **float** **api\_version:** REST API version
- **string** **message:** Message
- **integer** **status:** HTTP status code

##### On Failure

- **integer** **status:** HTTP status code.
- **string** **action:** Help message
- **string** **message:** Error message.

#### Status Codes:

- 200 **OK** Request accepted for processing
- 400 **Bad Request** Invalid URL
- 405 **Method is not allow** Invalid HTTP method request
- 422 **Unprocessable Entity** For missing or invalid parameters

#### Example request:

```
PATCH /api/op/presets/mute-meters file_data.json
```

```
file_data.json content:
```

```
{
  "meters": [
    {"meter_number": 14, "mute": "Y"},
    {"meter_number": 3, "mute": "N"},
    {"meter_number": 18, "mute": "Y"},
    {"meter_number": 1, "mute": "N"},
    {"meter_number": 8, "mute": "Y"}
  ]
}
```

#### Example responses:

A. On Success: All valid meters:

```
{
  "status": 200,
  "unit_name": "iAM-Series",
  "serial_number": "123456",
}
```

```
"model": "iAM-Mix-IP",
"message": "Mute meters have been applied successfully",
"api_version": 2
}
```

B. Invalid meter number:

```
{
  "status": 422,
  "action": "For more information about mute-meters, please see
            API document.",
  "message": {
    "meters":
      {
        "2": {
          "meter_number": ["Must be between 1 and 16."]
        }
      }
  }
}
```

C. Missing parameter:

```
{
  "status": 422,
  "action": "For more information about mute-meters, please see
            API document.",
  "message": {
    "meters":
      {
        "2": {
          "meter_number":
            ["Missing data for required field."]
        }
      }
  }
}
```

## Setting Solo Meter

Method: PATCH

URL: /api/op/presets/solo-meter

URL parameters:

- data Data in JSON format.

### Request

- Headers
  - Accept: application/json
  - Content-Type: application/json

### Response JSON Object

#### On Success

- string unit\_name: Product Name ("IAM-ETZ-G4")
- string model: Product model ("IAM\_MIX\_IP")
- string serial\_number: Product serial number
- float api\_version: REST API version
- string message: Message
- integer status: HTTP status code

#### On Failure

- integer status: HTTP status code.
- string action: Help message
- string message: Error message.

### Status Codes:

- 200 OK Request accepted for processing
- 400 Bad Request Invalid URL
- 405 Method is not allow Invalid HTTP method request
- 422 Unprocessable Entity For missing or invalid parameters

### Example request:

```
PATCH /api/op/presets/solo-meter file_data.json
```

file\_data.json content:

```
{
  "meter_number": 5
}
```

### Example responses:

A. On Success: All valid meter in preset:

```
{
  "status": 200,
  "unit_name": "iAM-Series",
  "serial_number": "123456",
  "model": "iAM-Mix-IP",
  "message": "Solo meter : 5 has been applied successfully",
  "api_version": 2
}
```

B. Invalid meter number:

```
{
  "status": 422,
  "action": "For more information about valid meter numbers, please
            see API document.",
  "message": {
    "meter_number": ["Must be between 1 and 16."]
  }
}
```

C. Missing parameter:

```
{
  "status": 422,
  "action": "For more information about valid meter numbers, please
            see API document.",
  "message": {
    "meter_number": ["Missing data for required field."]
  }
}
```

## Setting UnSolo Meter

Method: PATCH

URL: /api/op/presets/unsolo-meter

URL parameters:

- data Data in JSON format.

### Request

- Headers
  - Accept: application/json
  - Content-Type: application/json

### Response JSON Object

- string unit\_name: Product Name ("IAM-ETZ-G4")
- string model: Product model ("iAM\_MIX\_IP")
- string serial\_number: Product serial number
- float api\_version: REST API version
- string message: Message
- integer status: HTTP status code

### Status Codes:

- 200 OK Request accepted for processing
- 400 Bad Request Invalid URL
- 405 Method is not allow Invalid HTTP method request
- 422 Unprocessable Entity For missing or invalid parameters

### Example request:

```
PATCH /api/op/presets/unsolo-meter
```

### Example responses:

```
{  
  "status": 200,  
  "unit_name": "iAM-Series",  
  "serial_number": "123456",  
  "model": "iAM-Mix-IP",  
  "message": "UnSolo has been applied successfully",  
  "api_version": 2  
}
```



# Source Select

## Method: PATCH

### URL: /api/op/sourceselect

### URL parameters:

- **data** Data in JSON format.

#### Request

- **Headers**
  - Accept:** application/json
  - Content-Type:** application/json

*SourceType and input Source are case sensitive.*

#### 1. Body content for SDI

```
{
  "SourceType": <String: SDI Input Source>
}
```

**Note:** Allowed SDI input sources are:

```
"Sfp-1.Sdi.Sdi-1",
"Sfp-2.Sdi.Sdi-1"
```

#### 2. Body content for MADI

```
{
  "SourceType": <String: MADI Input Source>,
  "ChannelGroup": <Int: 1-4>
}
```

**Note:** Allowed SDI input sources are

```
"Madi.Coax" and
"Madi.Optical"
ChannelGroup 1 => Channels 1-16 and
ChannelGroup 2 => Channels 17-32 and so on...
```

#### 3. Body content for Analog

```
{
  "SourceType": "Analog"
}
```

#### 4. Body content for Aes

```
{
  "SourceType": "Aes"
}
```

#### 5. Body content for Aoip

```
{
  "SourceType": "Aoip",
  "ChannelGroup": <Int: 1-4> (Mix-IP 16) or <Int: 1-8> (Mix-IP 8)
}
```

#### 6. Body content for SMPTE 2022

**Note:** Allowed SMPTE 2110 input sources are:

```
"Sfp-1.Smpte2022",
"Sfp-2.Smpte2022",
```

```
{
  "SourceType": "Sfp-1.Smpte2022",
  "ChannelGroup": <Int: 1-4> (Mix-IP 16) or <Int: 1-8> (Mix-IP 8)
}
```

#### 7. Body content for SMPTE 2110

**Note:** Allowed SMPTE 2110 input sources are:

```
"Sfp-1.Smpte2110",
"Sfp-2.Smpte2110",
{
  "SourceType": "Sfp-1.Smpte2110",
  "ChannelGroup": <Int: 1-4> (Mix-IP 16) or <Int: 1-8> (Mix-IP 8)
}
```

**Note:** ChannelGroup 1 => Channels 1-16 and ChannelGroup 2 => Channels 17-32 and so on

### Response JSON Object

#### On Success

• string	<b>unit_name:</b>	Product Name ("IAM-ETZ-G4")
• string	<b>model:</b>	Product model ("iAM_MIX_IP")
• string	<b>serial_number:</b>	Product serial number
• float	<b>api_version:</b>	REST API version
• string	<b>message:</b>	Message
• integer	<b>status:</b>	HTTP status code

#### On Failure

• integer	<b>status:</b>	HTTP status code.
• string	<b>action:</b>	Help message
• string	<b>message:</b>	Error message.

#### Status Codes:

• 200	OK	
• 400	Bad Request	Invalid URL
• 404	Method is not allow	Invalid HTTP method request
• 422	Unprocessable Entity	For missing or invalid parameters
• 500	Server Error	Internal server error

### Example request:

```
PATCH /api/op/sourceselect file_data.json
file_data.json content:
```

```
{
  "SourceType": "Madi.Coax",
  "ChannelGroup": 4
}
```

### Example response:

#### A. On Success:

```
{
  "unit_name": "iAM-Series",
  "serial_number": "123456",
  "model": "iAM-Mix-IP",
  "message": "Input Source Madi.Coax has been applied successfully",
  "api_version": 2,
  "status": 200
}
```

#### B. On Failure: Invalid channel group:

```
{
  "status": 422,
  "action": "For more information about valid Input Sources, please
    see API document.",
  "message": {
    "ChannelGroup": ["Must be between 1 and 8."]
  }
}
```

C. On Failure: Invalid Source Type:

```
{
  "status": 422,
  "action": "For more information about valid Input Sources, please
    see API document.",
  "message": {
    "SourceType": ["Not a valid choice."]
  }
}
```

D. On Failure: Source not licensed:

```
{
  "status": 422,
  "action": "For more information about licensed keys, please contact
    Wohler Support.",
  "message": "Sfp-1.Smpte2022 Source Not Licensed"
}
```

## HTTP Routing Table

GET /api/cf/presets

GET /api/cf/presets/(int:preset Id)

GET /api/cf/presets/ presetbyname/(str:preset Name)

GET /api/cf/presets/current

PATCH /api/cf/presets/(int:preset Id)/activate

PATCH /api/op/presets/mute-meters

PATCH /api/op/presets/solo-meter

PATCH /api/op/presets/unsolo-meter

PATCH /api/op/sourceselect

## Status Codes

200	OK	
400	Bad Request	Invalid URL
404	Method is not allow	Invalid HTTP method request
422	Unprocessable Entity	For missing or invalid parameters
500	Server Error	Internal server error
505	HTTP version not supported	This API has been deprecated. It will be removed at some point in the future.