



AMP1-2SDA

**1RU, 2-Channel, 3G/HD/SD-SDI / AES / Analog
Audio Monitor**

User Guide

Software Release: V1.xx

Part Number 821817, Revision E

© 2020 Wohler Technologies, Inc. All rights reserved.

This publication is protected by federal copyright law. No part of this publication may be copied or distributed, stored in a retrieval system, or translated into any human or computer language in any form or by any means electronic, mechanical, manual, magnetic, or otherwise, or disclosed to third parties without the express written permission of Wohler Technologies, Inc.

Reproduction

Licensed users and authorized distributors of Wohler Technologies, Inc. products may copy this document for use with Wohler Technologies, Inc. products provided that the copyright notice above is included in all reproductions.

Customer Support

Wohler Technologies, Inc.
1280 San Luis Obispo Ave.
Hayward, CA 94544 www.wohler.com
Phone: 510-870-0810
FAX: 510-870-0811
US Toll Free: 1-888-596-4537 (1-888-5-WOHLER)
Web: www.wohler.com Sales: sales@wohler.com
Support: support@wohler.com

Disclaimers

Even though Wohler Technologies, Inc. has tested its equipment and software, and reviewed the documentation, Wohler Technologies, Inc. makes no warranty or representation, either express or implied, with respect to software, documentation, their quality, performance, merchantability, or fitness for a particular purpose.

In no event will Wohler Technologies, Inc. be liable for direct, indirect, special, incidental, or consequential damages resulting from any defect in the hardware, software, or its documentation, even if advised of the possibility of such damages.

Some states do not allow the exclusion or limitation for incidental or consequential damages, so the above exclusion or limitation may not apply to you.

Printing

This document looks best when printed on a color printer since some images may be indistinct when printed on a black and white printer.

PDF

All text strings appearing in [this shade of blue](#) are hyperlinks.

Other Technologies and Products

Google Chrome is a registered trademark of Alphabet Inc. Microsoft Windows and Internet Explorer are registered trademarks of Microsoft Corporation.

Last Update

February 21, 2020

TABLE OF CONTENTS

Contents

- User Guide 1
- TABLE OF CONTENTS 3
 - Contents 3
- CHAPTER 1: Quick Start 5
 - Introduction 5
 - Overview 5
 - Safety 5
 - Instructions 5
 - Safety Symbols 6
 - Mounting 6
 - Heat Dissipation 7
 - Sympathetic Vibration 7
 - Mechanical Bracing 7
 - Connections and Cable Recommendations 8
 - Electrical Interference 8
 - Power 8
 - Compliance 9
 - FCC 9
 - ICES-003 9
 - Front Panel 10
 - Rear Panel 11
- CHAPTER 2: Operation 15
 - Introduction 15
 - Main Screen 15
- CHAPTER 3: Option Settings 17
- CHAPTER 3: Option Settings 18
 - Introduction 18
 - Option Menu Overview 18
 - Option Settings 19
- CHAPTER 4: Features & Specifications 21
 - Introduction 21
 - Features 21
 - Compliance 22
 - Specifications 22
 - SDI Audio Formats 23
 - Technical Functional Overview 24

APPENDIX A: Firmware Updates 25
 Introduction 25
 Upgrading the Firmware Using a USB Flash Drive 26
 Possible Firmware Update Problems..... 27
APPENDIX B: Option Card Installation 28

CHAPTER 1: Quick Start

Introduction

Overview

The AMP1-2SDA is a 1RU, 2-channel, 3G/HD/SD-SDI, AES, and Analog audio monitor. This unit comes with a powerful audio amplifier to overcome ambient noise. It also has two 26-segment level meters for audio level metering. You can visually and audibly monitor any selected audio pair. There is also a 4-digit, 14-segment display for setup and status display. The AMP1-2SDA is small, low-cost, reliable and simple to operate.

Note that very little configuration should be necessary. We have already configured the unit to the most commonly requested settings. However, should you need to change these settings, you can quickly and easily access the optional settings using the front panel controls and the **Status Display**.

Safety

Instructions

1. Read, keep, and follow all of these instructions; heed all warnings.
2. Do not use this equipment near water.
3. Use only a dry cloth to clean the equipment.
4. Do not block any ventilation openings.
5. Do not install near any heat source such as a radiator, heat register, amplifier, or stove.
6. Do not attempt to plug the unit into a two-blade outlet (with only two prongs of equal width).

Important:

By design, this monitor will only plug into a three-prong outlet for your safety. If the plug does not fit into the outlet, contact an electrician to replace the obsolete outlet.

7. Protect the power cord from being walked on or pinched, particularly at plug connections on the equipment and at the socket.
8. Use only the attachments/accessories specified by the manufacturer.
9. Unplug the equipment during lightning storms or when unused for long periods of time.
10. Refer all servicing to qualified service personnel. Servicing will be required under all of the following conditions:
 - a. The equipment has been damaged in any way, such as when the power-supply cord or plug is damaged.
 - b. Liquid had been spilled or objects have fallen onto the equipment.
 - c. The equipment has been exposed to rain or moisture.
 - d. The equipment does not operate normally.
 - e. The equipment has been dropped.

Safety Symbols

WARNING:



The symbol to the left warns of electric shock hazard inside the unit. Disconnect the power cord before removing access panels when installing upgrades. Only qualified service personnel are to operate the equipment with covers removed, and are to exercise caution to avoid personal injury.

Mounting

The unit is designed for a standard 19" rack. Install it at ear/eye level for best high frequency response and visual observation of the display screens. Please adhere to the following clearances:

Table 1-1: Clearance Recommendations

Clearance	Surface
24"	Front
3"	Rear
2"	Sides
1.75"	Top and Bottom (if either radiates heat)
0"	Top and Bottom (if no heat)

Heat Dissipation

The ambient temperature inside the mounting enclosure should not exceed 40° Celsius (104° Fahrenheit). Adjacent devices can be rack mounted (or stacked) in proximity to the unit if this temperature is not exceeded. Otherwise, allow a 1RU (1.75"/44.45mm) space above and below the unit for air circulation.

Important:

To reduce noise, the monitor does not have any fans. As a result, the heat generated by the class D power amplifiers, power supplies, and other components is vented by slots in the sides and back of the unit. Therefore, as a safety precaution, you must allow proper ventilation on these surfaces.

Sympathetic Vibration

Sympathetic vibration from other equipment (cables, etc.,) in the rack may be serious enough to interfere with the sound quality of the unit. If you experience sympathetic vibrations, use thin card stock, felt, foam, or weather-stripping between the vibrating surfaces. Tie loose cables securely with cable ties.

Mechanical Bracing

The 1RU chassis is securely attached to the front panel. In addition, the chassis has mounting tabs through which you attach it to the rack rail. This feature will reduce or eliminate rear bracing requirements in many mobile/portable applications. The weight of internal components is distributed fairly evenly around the unit.

Connections and Cable Recommendations

We recommend that you limit the length of the cables that you use for feeding 3G/HD/SD-SDI signals sources to the SDI connector and that you use a Belden 1694A cable (or equivalent).

Table 1-2: SDI Cable Length Limit Recommendations

Signal Type	Maximum Length	
	Meters	Feet
SD	300	984
HD	150	492
3G	75	246

Note

The connections of all DB-25 connectors are compatible with Tascam DB-25 to XLR cable assemblies. Consult the factory for availability. All rear-panel connectors are female except the XLR output connectors.

Electrical Interference

Be careful to avoid mismatched cable types and other similar causes of undesired reflections in digital signal systems. If severe enough, such reflections can result in corruption of the digital data stream. As with any audio equipment, maximum immunity from electrical interference requires the use of shielded cable; however, satisfactory results can sometimes be obtained without it. The internal circuitry ground is connected to the chassis.

Power

The unit comes with a standard internal power supply and connects an A/C mains power source (60W, 100 to 240 VAC, $\pm 10\%$, 50/60Hz) through the IEC connector provided on the rear panel of the unit.

When the mains plug or appliance coupler is used as the disconnect device, the disconnect device should remain operable.

Compliance

FCC

This equipment has been tested and found to comply with the limits for a Class A digital device, pursuant to part 15 of the FCC Rules. These limits are designed to provide reasonable protection against harmful interference when the equipment is operated in a commercial environment. This equipment generates, uses, and can radiate radio frequency energy and, if not installed and used in accordance with the instruction manual, may cause harmful interference to radio communications. Operation of this equipment in a residential area is likely to cause harmful interference, in which case the user will be required to correct the interference at their own expense.

ICES-003

This Class A digital apparatus complies with Canadian ICES-003.

Cet appareil numérique de la classe A est conforme à la norme NMB-003 du Canada.

Front Panel

This section provides a description of each control or indicator on the front panel.

Figure 1-1: Front Panel Layout

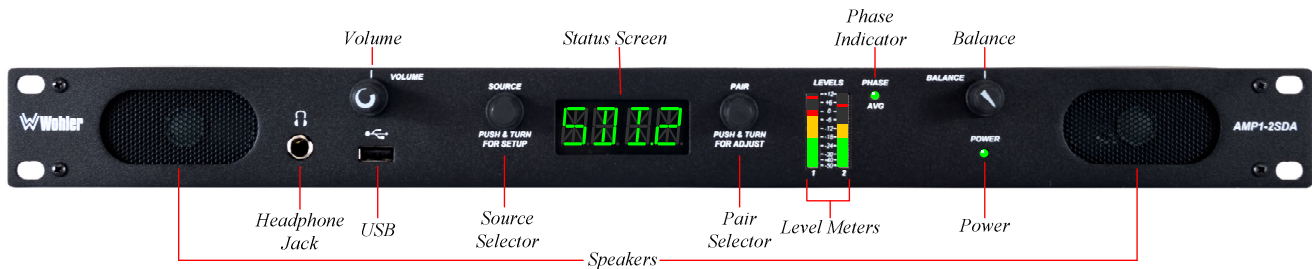

1. **Volume:** The **Volume** knob controls the volume of the internal speakers, headphones, and optionally of the rear panel balanced analog outputs.
2. **Status Screen:** Typically the **Status Screen** displays the selected audio source and channel pair. In Figure 1-1, the selected source is the 3G/HD/SD-SDI input and the selected channel pair if pair 2, for example. The **Status Screen** is also used to assist in setting up options.
3. **Phase Indicator:** This LED provides a green indication if the two channels are in phase, on average. It provides a red indication if the two channels are out of phase, on average.
4. **Balance:** The **Balance** knob adjusts the left/right balance between the speakers, headphones, and optionally between the rear panel balanced analog outputs.
5. **Headphone Jack:** A 1/4" stereo jack for optional headphones is provided on the front panel.
6. **USB 2.0 Port:** This USB Type A connector allows you to use a flash drive (not supplied) to update the unit's firmware. Refer to Appendix A.
7. **Source Selector:** This knob allows you to select the input source: analog, AES, or SDI. To set up the various options in the AMP1-2SDA, press this knob for at least 3 seconds. Chapter 3 describes reviewing and changing options.
8. **Pair Selector:** This knob allows you to select the specific channel pair to be monitored from multi-channel sources. It also has secondary functions when configuring options. Chapter 3 describes reviewing and changing options.
9. **Level Meters:** Two 26-segment meters provide left and right channel metering. These high-resolution LED bar graph displays feature a dynamic range of 66 dB with PPM dot over VU bar ballistic characteristics.
10. **Power Indicator:** This green LED indicates that the AMP1-2SDA is receiving AC power.
11. **Speakers:** Audio monitoring is achieved through the use of Class D amplifiers driving two (left/right) wide range speakers.

Rear Panel

This section provides a description of each connector on the rear panel, as well as diagrams for each XLR or DB25 connector.

Figure 1-2: Rear Panel Layout

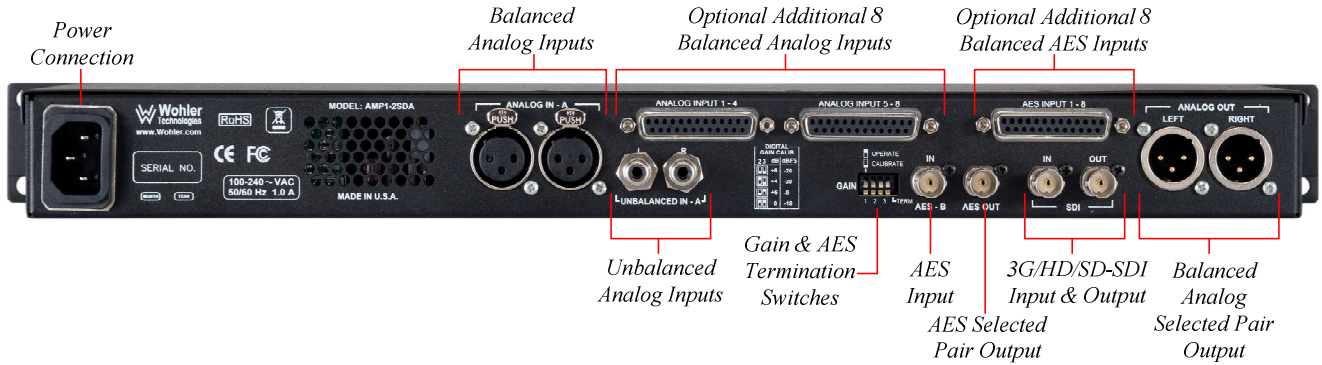

1. **Power Connection:** The AMP1-2SDA uses a standard IEC power cord for the 100 to 240 VAC $\pm 10\%$, 50/60 Hz power connection.
2. **Balanced Analog Inputs:** These two XLR-F connectors accept left and right balanced analog line level input signals. Connect to either the Balanced Analog Inputs or the Unbalanced Analog inputs. If you connect to both, they will mix, but this is not considered normal operation. Refer to Figure 1-3 for the wiring connections of each connector.

Figure 1-3: Balanced Analog Input XLR-F Pin Out

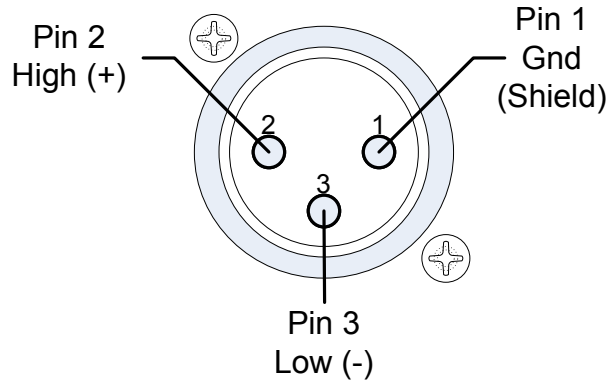

3. **Optional Additional 8 Balanced Analog Inputs:** Each of these two DB-25-F connectors accept four left and right balanced analog line level input signals. Refer to Figure 1-4 for the wiring connection of each connector.

Figure 1-4: Balanced Analog Input XLR-F Pin Out

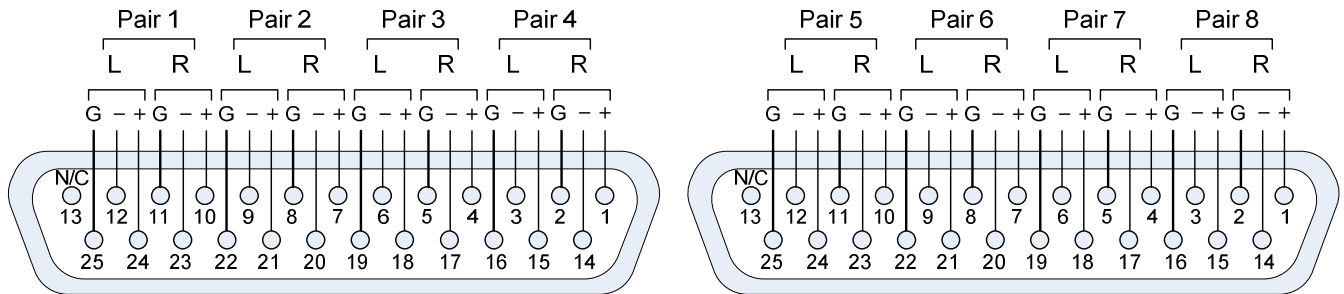

4. **Optional Additional 8 Balanced AES Inputs:** This DB-25-F connector accepts eight balanced AES input Channel pairs. Refer to Figure 1-5 for the wiring connections of this connector.

Figure 1-5: Balanced AES Input XLR-F Pin Out

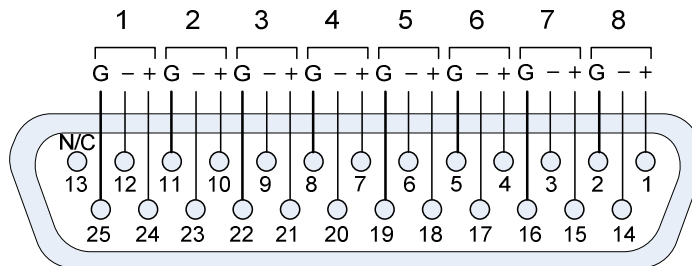

Note

The connections of all DB-25 connectors are compatible with Tascam DB-25 to XLR cable assemblies. Consult the factory for availability. All rear-panel DB-25 connectors are female.

5. **Unbalanced Analog Inputs:** These two RCA connectors accept left and right unbalanced analog component audio level input signals. Use either the Balanced Analog Inputs or the Unbalanced Analog Inputs. If you use both, they will mix, but this is not considered normal operation.

6. **Gain & AES Termination Switches:** These switches perform the following functions:
- Operate / Calibrate** (Switch 1) is set to Operate (up) by default. This switch is not implemented and is reserved for possible future use.
 - Analog to Digital Reference Level** (Switches 2 & 3) allow you to adjust the analog level that will correspond to a metered value. The default setting is +4 dBu analog = -20 dBFS digital (Switch 2 up, 3 down). A +4 dBu analog input level will display as a -20 dBFS reading on the bar graph meters and also transition from green to amber at that segment. Refer to the silk-screened chart on the rear panel or to Table 1-3.

Table 1-3: Analog to Digital Reference Level

Switch		Reference Level	
2	3	Analog (dBu)	Digital (dBFS)
Down	Down	+8	-20
Up	Down	+4	-20
Down	Up	+6	-9
Up	Up	0	-18

- AES Termination** (Switch 4) allows you to set or remove the termination on the unbalanced 75Ω AES input. The default is OFF (down). Set the termination to ON (up) only if this is the last in a series of AES connections.
- Unbalanced AES Input:** This BNC connector accepts an unbalanced 75Ω AES input signal to be monitored. If this is the last AES connection in a series, set the Termination Switch to ON (up). Refer to Item 6c of this chapter. There should never be two terminations in an AES cable connection.
 - Unbalanced AES Output:** This BNC connector produces a 75Ω unbalanced AES output signal consisting of the audio channel pair selected from any of the inputs.
 - 3G/HD/SD-SDI Input:** This BNC connector accepts a 3G/HD/SD-SDI input signal to be monitored. Refer to Table 1-2 for considerations regarding cable length for this input.
 - 3G/HD/SD-SDI Output:** This BNC connector regenerates the 3G/HD/SD-SDI input signal.

11. **Balanced Analog Outputs:** These XLR-M connectors provide left and right balanced analog signals consisting of the selected, metered audio channel pair from any of the inputs. There are also several options that will affect the signal level of the Balanced Analog Output. Refer to the Option Settings section of Chapter 3 for explanations of these options. Refer to Figure 1-6 for the wiring connections of each connector.

Figure 1-6: Balanced Analog Output XLR-M Pin Out

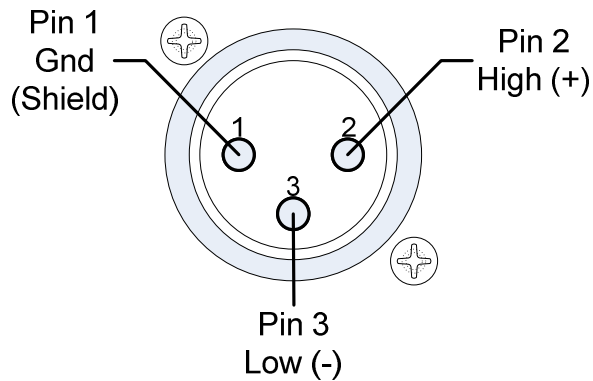

CHAPTER 2: Operation

Introduction

This chapter describes how to operate the AMP1-2SDA. It is a good idea to connect any or all of the inputs you will be monitoring before proceeding in this chapter.

Main Screen

When the AMP1-2SDA is powered, it will first test the **Status Display** by lighting all of the segments, as shown in Figure 2-1, for one second:

Fig 2-1: Display Test

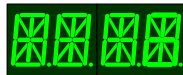

Then it will display part of the product name, as shown in Figure 2-2, for one second:

Fig 2-2: Product Name

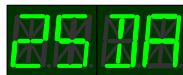

Following this, it will display the version number of its software in the format shown in Figure 2-3 for two seconds:

Fig 2-3: Software Version

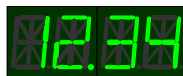

Finally, it will display the input selection, which is the last selected input type and pair before the power was removed from the unit. The **Status Display** will appear as shown in Figure 2-4 below.

Fig 2-4: Status Display

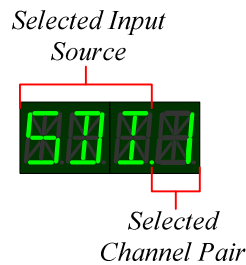

Note

Throughout the remainder of this manual, characters in the **Status Display** will be shown in text in the following format: **SDI.1**

Turn the **Source** knob to select a different source. The **Status Display** will change immediately as you turn the knob. Turning the **Pair** knob will select a pair within that source if there is more than one. Table 2-1 shows the possible **Source** and **Pair** selections. Note that if an optional AES or Analog source is not installed, then it will not be presented as a possible choice as you rotate the **Source** knob.

Table 2-1: Source and Channel Pair Displays

Input	Display	Channel Pair Range
3G/HD/SD-SDI BNC	SDI.	1 through 8
AES Unbalanced BNC	AES.	B only
Analog Balanced XLR x 2 or Analog Unbalanced RCA x 2	ANA.	A only
AES Balanced DB25 (Optional)	AES.	1 through 8
Analog Balanced DB25 x 2 (Optional)	ANA.	1 through 8

After selecting a **Source** and a **Pair**, adjust the **Volume** and **Balance** controls to suitable levels. The **Level Meters** will display the level of the selected channel pair of the selected input source. If the **Phase Avg** indicator is green, this indicates that the two channels of the selected channel pair are, on average, in phase. If the **Phase Avg** indicator is red, this indicates that the two channels of the selected channel pair are, on average, out of phase.

The selected **Source/Pair** will also be output from the Headphone Jack, from the

Analog Output connectors, and from the AES Output connector. The signals in the Analog Output connectors can optionally be controlled by the **Volume** and **Balance** controls. Refer to Chapter 3.

If the pair selected from a digital source is unlocked or if the source is not connected, the display will alternate between and **Source/Pair** selection and **UNLK**. If the pair selected from a digital source contains an encoded signal that is not PCM, the **Source/Pair** selection will alternate with **CMPR**. Either of these indications mean that the audio on the selected pair cannot be monitored audibly or shown on the level meters.

Note

Anytime the AMP1-2SDA power is cycled, the last source and pair selected will be recalled from non-volatile memory. The selection is saved 15 seconds after the last change is made. The periods in the display will flash to indicate this. If power is removed from the unit before this occurs, the previously saved source will be recalled.

CHAPTER 3: Option Settings

Introduction

This chapter explains the uses for the various option settings provided in the product, as well as how to adjust them.

Option Menu Overview

You can launch the **Option Menu** system by pressing and holding the **Source** control for at least three seconds. After the first setting (Analog Out) appears, rotating the **Source** control will move from setting to setting. Table 3-1 lists the option settings in the order in which they will be encountered.

Table 3-1: Option Settings

Option Setting	Display	Possible Settings	Description
Analog Out	AOUT	TRIM	The Analog Output will be affected by the Analog Out Trim setting.
		FIX	The Analog Output will be fixed at the same level as the input signal.
		V/B	The Analog Output will be affected by the Volume and Balance controls.
		MUTE	The Analog Output will be muted.
Analog Out Trim	ATRM	-60 to +12	Adjusts from -60 dB to +12 dB in 1 dB steps, affecting the Analog Output signals.
Speaker Adjust	SPKR	NORM	Best for most situations.
		LOUD	Use when louder output is needed.
		MUTE	The internal speakers will be muted.
Treble Adjust	TREB	-12 to +12	Adjusts from -12 dB to +12 dB in 1 dB steps affecting the sound from the speakers and optional headphones.
Bass Adjust	BASS	-12 to +12	Adjusts from -12 dB to +12 dB in 1 dB steps affecting the sound from the speakers and optional headphones.
Display Brightness	BRGT	HIGH or LOW	Two possible settings affecting the Status Display , the Level Meters , and the Phase AVG indicator.
Factory Reset	FRST	NO or YES	Resets all options to factory defaults.

Option Settings

The various option settings are discussed in detail in this section. After holding the **Source** control for at least 3 seconds and entering the **Option Menu** system, rotating the **Source** control will allow you to review the settings. Each setting is displayed by alternating the name of the setting with the value of the setting. For example a Display Brightness setting of High would be shown as:

BRGT HIGH BRGT HIGH

To change a setting, first turn the **Source** control to the option you want to adjust. Then turn the **Pair** control to the setting you want for that option. To accept the new setting, just turn the **Source** control to the next option you want to adjust, if any.

When you are finished making all of the adjustments you want, press either the **Source** or **Pair** control for at least 3 seconds to exit the **Option Settings** section. Alternatively, you may just do nothing and wait. The **Option Settings** section will automatically exit after 10 seconds of no activity.

1. **Analog Out:** When **AOUT** appears, it will alternate with its setting. Turning the **Pair** control will change through the possible settings:
 - a. **TRIM** sets the Analog Output level to the value you set in the **Analog Out Trim** setting.
 - b. **FIX** is the default setting. No gain adjustments will be made to the Analog Output levels.
 - c. **V/B** causes the Analog Output level to be controlled by the **Volume** and **Balance** controls. This setting can be useful if the Analog Output connections will be used to drive external amplifiers and speakers for listening. The analog outputs are muted when headphones are inserted.
 - d. **MUTE** The Analog Outputs will mute regardless of any other setting.
2. **Analog Out Trim:** The **ATRM** setting will only appear if the **Analog Out** option is set to **TRIM**. When the **ATRM** option appears, turning the **Pair** control will adjust or trim the level of the Analog Output connections to the desired level. A full range of adjustment from -60 dB to +12 dB is available. The default setting is 0 dB. It is helpful to be listening to the Analog Output through the external piece of equipment that you have connected it to when making this adjustment.

3. **Speaker Loudness:** The **SPKR** setting affects the sound out of the speakers. The **NORM** option is the factory default and is suitable for most applications. The **LOUD** option is designed to be used when the selected audio source is quiet, or when the ambient noise of the room is loud. The **LOUD** option trades a flat frequency response for more gain where you need it most, and compresses the dynamic range of the audio source. This setting in combination with the **TREB** and **BASS** settings allows you to tailor the speaker response to your needs. The **MUTE** option is designed to be used if external speakers are connected to the **Analog Outputs**.
4. **Treble:** The **TREB** adjustment affects the sound of the internal speakers and the Headphone Jack. 0 dB is the default setting. Adjust it anywhere between -12 dB and +12 dB, according to your preference. Lowering **Treble** compensates for high frequency pre-emphasis or removes sibilant effects. Increasing **Treble** will add "sizzle" to the sound and bring high-pitched sounds out of the mix.
5. **Bass:** The **BASS** adjustment affects the sound of the internal speakers and the Headphone Jack. 0 dB is the default setting. Adjust it anywhere between -12 dB and +12 dB, according to your preference. Lowering **Bass** will unmask midrange band sounds, while increasing **Bass** will make the sound "fatter".
6. **Display Brightness:** The **BRGT** adjustment has two settings. The default setting is **HIGH**. It adjusts the brightness of the **Status Display**, the **Level Meters**, and the **Phase AVG** indicator. Adjust the setting for easy readability according to the ambient lighting conditions.
7. **Factory Reset:** When set to **YES**, the **FRST** menu item will set all options to their factory defaults when you exit the menu system. The menu item automatically returns to **NO** when the menu system is entered again.

Note

New settings are automatically written to non-volatile memory fifteen seconds after the last change is made. All of the periods in the display are flashed to indicate this. Do not remove power from the unit until this happens, or your changes will not return when power is reapplied to the unit.

CHAPTER 4: Features & Specifications

Introduction

This chapter lists the features and specifications of the AMP1-2SDA.

Features

1. High fidelity Class D amplifiers with Wohler quality sound
2. Quick selection of 3G/HD/SD-SDI, AES, and analog channel pairs to monitor through built-in speakers, headphones and analog outputs
3. Regenerated loop output of the SDI input
4. Balanced stereo analog outputs on XLR-M can be fixed, controlled by the **Volume** and **Balance** controls, or can be trimmed to various levels
5. Front panel ¼" headphone jack
6. Automatic frame rate detection and selection
7. Level metering for 2 (of 16) de-embedded 3G/HD/SD-SDI channels
8. High resolution metering with 26 segments displayed
9. Level Meter Representation: Simultaneous average and PPM
10. Brightness control for displays, 2 levels
11. Permanent internal storage for all option settings
12. Easy software updates using a USB flash drive
13. Shallow chassis depth for easy installation in OB vehicles and consoles
14. IEC power input, 100 – 240 VAC +/- 10%, 50/60 Hz
15. Phase indicator for the selected stereo input channel pair
16. Simple uncluttered front panel controls
17. Selectable trim and tone controls
18. Option to add monitoring of an additional 8 pairs of AES and/or Analog inputs.

Compliance

All components comply with UL, CE, and RoHS specifications.
The AMP1-2SDA meets FCC Part 15 compliance.

Specifications

Table 4-1: Specifications

Specification	Values / Domains
Power Requirements	100 VAC to 240 VAC \pm 10%, 50/60Hz
Power Consumption	60 Watts
Dimensions (H x W x D)	1.75" x 19" x 4.25" (44mm x 483mm x 107mm)
Weight	5 lbs. (2.3 kg)
Space Required	1 RU (rack unit)
Supplied Accessories	AC Power Cord (North America)
Inputs	SDI: 3G/HD/SD-SDI on BNC AES: L/R on BNC (Optional) 8 x L/R on DB25F Analog: Balanced L/R on XLR-F Unbalanced L/R on RCA (Optional) Balanced 8 x L/R on 2 x DB25F
Outputs	<ul style="list-style-type: none"> • SDI: regenerated on BNC • AES: L/R on BNC • Analog: Balanced L/R on XLR-M
Level Meters	2 x 26 segment LED
Level Meter Scale	AES
Status Display	4 x 14-segment green LED
Peak Acoustic Output	90dB SPL (@ 2 feet)
Power Output RMS	5 W RMS, 12 W peak (each side)
Acoustic Frequency Response	150 Hz to 16 kHz (\pm 5 dB)
Analog Output Reference Level	-20 dBFS = +4 dBu (\pm 1.0 dBu)
Analog Output Frequency Response	40 Hz to 20 kHz (\pm 1dB)
Analog Output Distortion	<0.01% THD+N

Specification	Values / Domains
Maximum Analog Input Level	+28 dBu
Maximum Analog Output Level	+28 dBu, +24 dB into 600Ω
A/D and D/A Dynamic Range	> 96 dB
SDI Input Termination	75Ω unbalanced
AES Input Terminations	75Ω unbalanced, switchable 110Ω balanced (optional module)
Analog Input Impedance	27K minimum balanced
Hum and Noise	Better than -68 dB below full output
Electrical Distortion	< 0.05% at any level below limit threshold

SDI Audio Formats

All of the SDI audio formats listed in Table 4-2 below are available for monitoring in the AMP1-2SDA.

Table 4-2: SDI Audio Formats

Standard	Format	Rate
SD		29.97; 25
HD	720p	23.98; 24; 25; 29.97; 30; 50; 59.94; 60
	1035i	29.97; 30
	1080i	25; 29.97; 30
	1080sf	23.98; 24; 25; 29.97; 30
	1080p	23.98; 24; 25; 29.97
3G	1080p	50; 59.94; 60

Technical Functional Overview

Figure 4-1 illustrates the overall functionality of the AMP1-2SDA monitor.

Figure 4-1: AMP1-2SDA Block Diagram

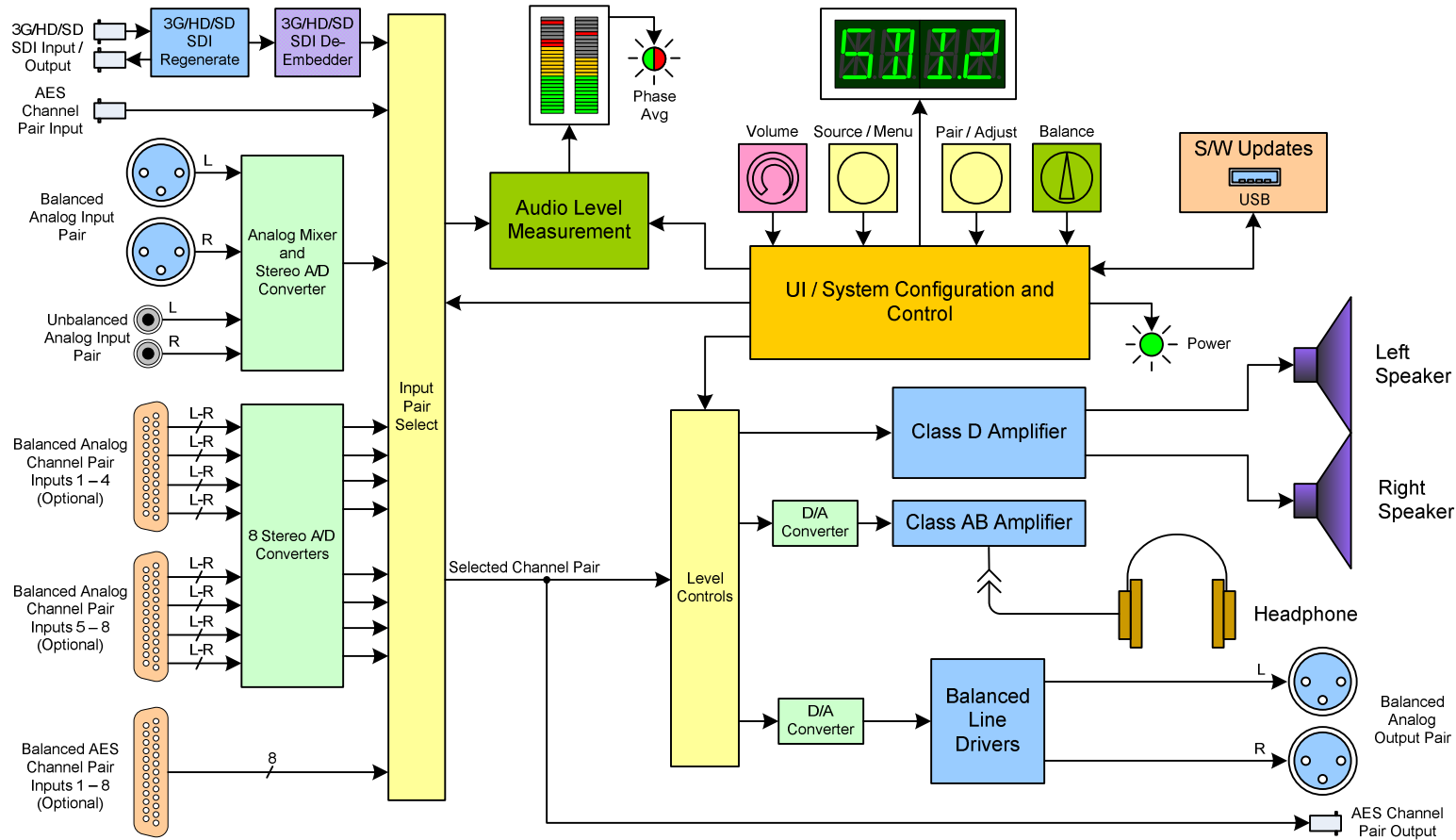

Note: Stereo phase indication measurement occurs in the signal chain before it is routed to the speakers.

APPENDIX A: Firmware Updates

Introduction

This chapter describes how to install firmware upgrades into AMP1-2SDA using a USB Flash Drive. The USB Flash Drive must meet the following requirements to be suitable for use in updating the AMP1-2SDA:

1. Must be formatted with a FAT-32 file system.
2. The block size must be 512 bytes.
3. It must have only one volume and only one partition.
4. The directory structure of the firmware update zip file, starting with the Wohler folder must not be changed.

Note:

When a new version becomes available, software updates may be obtained in .zip file format from the Wohler website. Download this zip file, unzip it, and place the "Wohler" folder on a flash drive. Be sure to check the "Do I Need This Update" file for revision notes.

Upgrading the Firmware Using a USB Flash Drive

1. Remove power from the unit.
2. Insert the USB Flash Drive (prepared as written above) into the unit, and restore power to the unit.
3. Within 10 seconds this message is displayed: **USB DET.**
In other words, "A USB Flash Drive is detected."
4. The main firmware will be updated, and the unit will display **PRGM OK. PULL USB TO RUN.**
5. Remove the Flash Drive from its front panel connector to allow the new application to run.
6. Once the new application is running, reinsert the USB flash drive to program the FPGA.
7. Once the USB drive is detected, the unit will display **USB DET. PUSH SRC TO STOP OR PAIR TO PRGM. USB TO RUN.**

You want to push the **Pair** encoder to allow the FPGA update to continue. Pressing **Source** will cancel the update.

8. After pressing **Pair** to continue the firmware update, there will be a series of sequential messages which indicate the updating progress. **Do Not Remove the flash drive during this process!** The process will take several minutes.
9. During the firmware update, you may see various progress messages. They are for informational purposes only and do not require any action on your part. There may be any or all of the following messages, with each word displayed sequentially:

FPGA CHECK 0.12

FPGA PRGM 0.16

FPGA PRGM OK. WILL RSET TO PRGM APP.

10. When the firmware update completes successfully, the following message will be sequentially displayed: **PRGM OK. PULL USB TO RUN.**
11. At this point the firmware update is complete and you should remove the Flash Drive from its front panel connector. The AMP1-2SDA will restart, behaving exactly as if you had just connected its power plug to power.

This concludes the USB firmware update procedure.

Possible Firmware Update Problems

This section describes what you should do if error messages appear during the firmware update.

1. Error message: **FPGA PRGM FAIL. PULL USB TO RSET.** This means that a programming problem occurred and that you must remove the Flash Drive. Return to Step 6 in the previous section and re-insert the Flash Drive to try again.
2. Error message: **PRGM FAIL. PULL USB AND TRY ONCE MORE** This means that a programming problem occurred and that you must remove the Flash Drive. Return to Step 1 in the previous section and re-insert the Flash Drive to try again.
3. Error message: **NO APP. USE USB TO PRGM.** This means a programming problem occurred and that you must remove the Flash Drive. Return to Step 1 in the previous section and re-insert the Flash Drive to try again.
4. No message is displayed, but after the update process the unit will not operate at all: Unplug the AMP1-2SDA from power. Insert the Flash Drive. Reconnect the AMP1-2SDA to power. The display will show **USB DET WAIT** for 10 seconds and then the software update will resume. Continue with Step 1 of the procedure in the previous section.

If any of the problems listed above persist, please contact Wohler Technologies, Inc. Technical Service for assistance.

APPENDIX B: Option Card Installation

823531 Rev A Instructions AMP1-2SDA (8103-0200) Option Card Installation:

Notes:

1. To open unit, remove lid.
2. Install **829095 (AES)** and/or **829096 (ANALOG) OPTION CARDS** using attachment hardware.
3. Close unit securing lid.

Parts List: 829095 (AES)

ITEM	Description	QTY
1.	AMP1-2SDA	1
2.	919462 16 CH AES OPTION CARD	1
3.	286049 STANDOFF 4-40 X 5/8" NYLON	1
4.	281443 SCREW 4-40 X 3/16"	1
5.	281871 JACKSCREW	2

Parts List: 829096 (ANALOG)

ITEM	Description	QTY
1.	AMP1-2SDA	1
2.	919463 16 CH ANALOG OPTION CARD	1
3.	286049 STANDOFF 4-40 X 5/8" NYLON	1
4.	281443 SCREW 4-40 X 3/16"	1
5.	281871 JACKSCREW	4

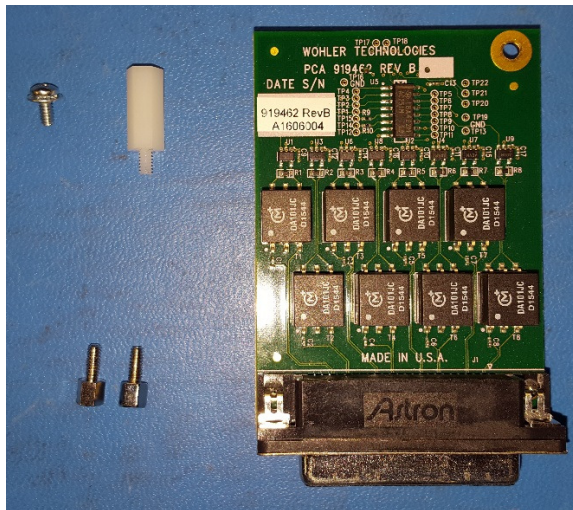

OPT 829095 (AES) – 919462



OPT 829096 (ANALOG) – 919463

Procedure:

1. Remove lid



2. Remove and discard rear cover plate and screws.

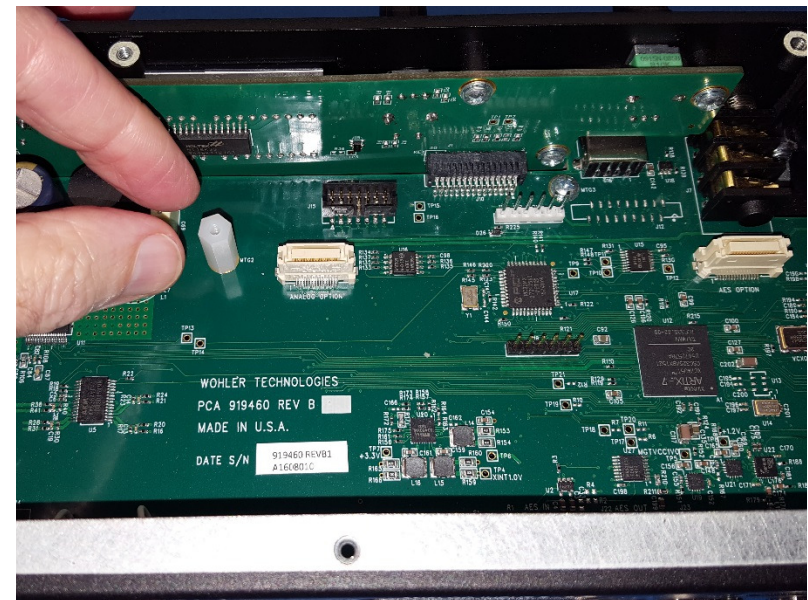
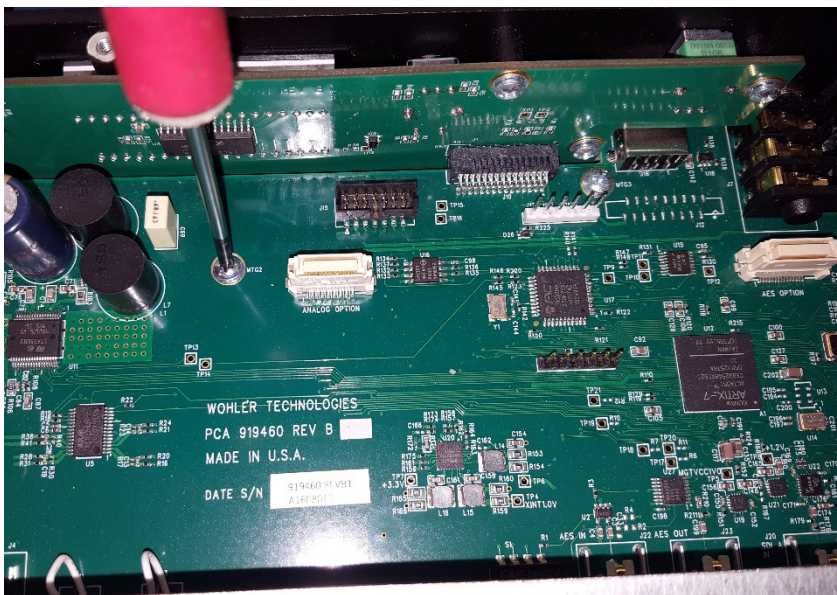

3. Remove screw or standoff that secures MB to chassis located at MTG2 and/or MTG4.

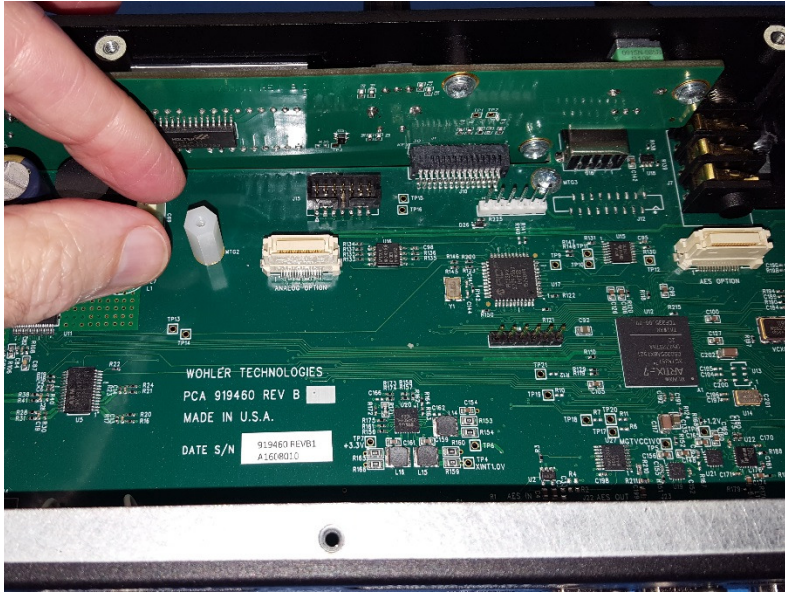

4. Install 286049 5/8" long nylon M-F standoff at MTG2 or MTG4.

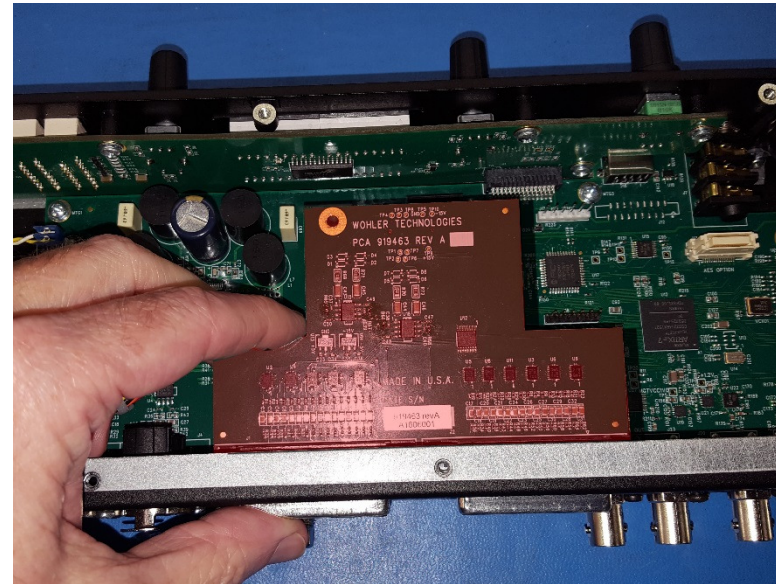

5. Install option card thru rear panel and seat onto MB connector.

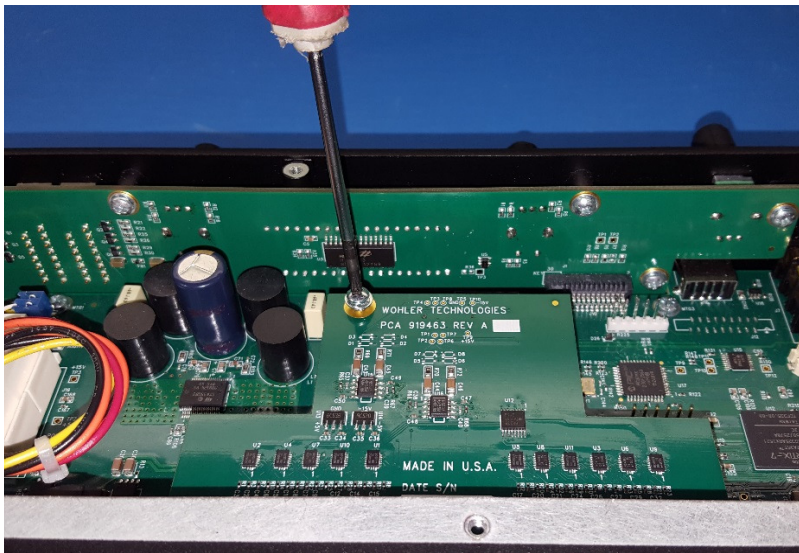

6. Secure option card to nylon standoff with 4-40 screw.
8. Re-lid cover and secure with original screws.
9. Done.



7. Secure option card to rear panel using jackscrews.